



CONTENT



Coffee machines	12
Coffee grinder	17
Espresso machine	16
Kettle	19
Milk frother	17
Tea/coffee station	24
Water kettle	22



Automatic toasters	24
Cake pop maker	29
Cotton candy maker	33
Chocolate fountain	34
Crêpe maker	28
Donut maker	29
Egg boiler	34
Ice cream maker	32
Ice cream cone maker	28
Ice cube maker	32
Muffin maker	29
Multi grill	31
Pepper/salt mill	35
Popcorn maker	34
Sandwich toaster	30
Soft ice cream maker	33
Waffle maker	27
Yoghurt maker	33



Automatic juicer	53
Bag sealer	56
Bar mixer / milk frother	52
Can opener	56
Citrus fruit squeezer	52
Deep fat fryers	57
Electric knife	36
Fondue deep fat pan	57
Food dryer	55
Food processor	42
Food slicer	35

Hand blender	36
Hand blender set	38
Hand mixer	40
Hand mixer set	41
Kitchen scales	54
Kneading and stirring machine	43
Mincer	49
Multi express	38
Multi chopper	39
Smoothie maker	51
Universal mixer	49

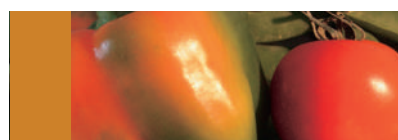

Alcohol tester	81
Bread maker	61
Barbecue standing grill	69
Barbecue table grill	71
Built-in microwaves with grill	79
Contact grill	63
Convection oven	72
Electric grill lighter	69
Fondue set	67
Gas grill	76
Hot dog maker	62
Hotplates	81
Induction hot plates	82
Microwaves	75
Mini kitchen	75
Mini oven	73
Multi oven	75
Multi pizza oven	73
Teppanyaki grill	64
Party pans	64
Pizza maker	72
Raclette grills	68
Rice cooker	60
Preserving boiler	81
Steam cooker	62



Steam irons	84
Fabric steamer	89
Mini-washing machine	89
Steam ironing units	88
Travelling steam iron / steam brush	83



Battery vacuum cleaner	94
Floor vacuum cleaner	96
Hand vacuum cleaner	95
High-pressure cleaner	92
Steam cleaner	90
Steam mop	93
Textile cleaner	102
Wet and dry cleaner	101
Window cleaner	92

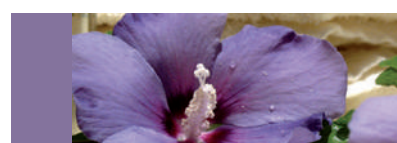

Baby food warmer	104
Bathroom scales	103
Digital thermometer	104
Foot massager	105
Hair and beard trimmer	106
Hair crimper / Hot air styler	108
Hair dryer	109
Luggage scale	102
Manicure/pedicure set	105
Massage equipment	105
Men's shaver	107
Multicurler	107
Nose and ear hair remover	106
Sterilizer	104

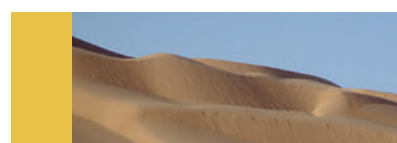

Accessories	120
Air conditioning units	114
Air dehumidifier	117
Convector heaters	115
Cool boxes	116
Fan heater	117
Insect killer	119
Standing fan	113
Table fans	112
Tower fan	113



Universal mixer
UM 3561 => page 50

Kettle
WK 3559 => page 21



Automatic toaster
TA 3557 => page 26



Multi chopper
MZ 3560 => page 40



Coffee machine
KA 3558 => page 14





Coffee machine
KA 3552

- For 8–10 cups of coffee (approx. 1,25 litre)
- Anti-drip protection
- Swivel filter
- On/off switch with indicator light
- Water level indicator
- Heating plate with automatic switch-off
- 230 V, 50 Hz, 870 W max.

Automatic toaster
TA 3551

- Compact 2-slice toaster
- Cool touch housing
- Bun warmer (removable)
- Defrost/reheat/quick-stop function
- Continuously adjustable thermostat
- 3 indicator lights
- Automatic/manual switch-off
- Crumb drawer
- Cord storage
- 230 V, 50 Hz, 600–700 W. max.

Kettle
WK 3553

- Max. capacity 1.7 litre
- Simple handling due to cable free technology – easy to pour in and out
- Safety hinged lid
- Lime filter (removable)
- On/off switch (illuminated)
- Stainless steel heating element
- Automatic/manual switch-off
- External water level indicator
- Base station with cord storage
- Evaporation/overheating protection
- 230 V, 50 Hz, 2200 W



Coffee machine
KA 3575

- For 8–10 cups of coffee (approx. 1.25 litre)
- Stainless steel insert
- Anti-drip protection
- Filter holder (removable)
- On/off switch with indicator light (blue illuminated)
- Water level indicator
- Heating plate with automatic switch-off
- 230 V, 50 Hz, 1000 W



Automatic toaster
TA 3574

- 2-slice toaster
- Stainless steel insert
- Cool touch housing
- Bun warmer (integrated)
- Defrost/reheat/quick-stop function
- Continuously adjustable thermostat
- 3 indicator lights (blue illuminated)
- Centring function
- Automatic/manual switch-off
- Crumb drawer
- Cord storage
- 230 V, 50 Hz, 850 W



Kettle
WKS 3576

- Max. capacity 1.5 litre
- Stainless steel insert
- Simple handling due to cable-free technology – easy to pour in and out
- 360° connector
- Lockable safety hinged lid with one-handed operation
- Lime filter (removable)
- On/off switch (blue illuminated)
- Concealed stainless steel heating element
- Automatic/manual switch-off
- 2 external water level indicators
- Base station with cord storage
- Evaporation/overheating protection
- 230 V, 50 Hz, 2200 W





Coffee machine KA 3555

- For 8–10 cups of coffee (approx. 1,25 l)
- Anti-drip protection
- Swivel filter
- On/off switch with indicator light (blue illuminated)
- Water level indicator
- Heating plate with automatic switch-off
- 230 V, 50 Hz, 870 W max.



Kettle WK 3556

- Max. capacity 1.7 litre
- Simple handling due to cable-free technology – easy to pour in and out
- Safety hinged lid
- Lime filter (removable)
- On/off switch (blue illuminated)
- Stainless steel heating element
- Automatic/manual switch-off
- External water level indicator
- Base station with cord storage
- Evaporation/overheating protection
- 230 V, 50 Hz, 2200 W



Automatic toaster TA 3554

- Compact 2-slice toaster
- Cool touch housing
- Bun warmer (removable)
- Defrost/reheat/quick-stop function
- Continuously adjustable browning
- 3 indicator lights (blue illuminated)
- Automatic/manual switch-off
- Crumb drawer
- Cord storage
- 230 V, 50 Hz, 870 W max.

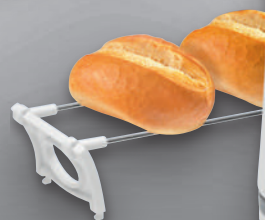

Coffee machine KA 3555

- For 8–10 cups of coffee (approx. 1.25 litre)
- Anti-drip protection
- Swivel filter
- On/off switch with indicator light (blue illuminated)
- Water level indicator
- Heating plate with automatic switch-off
- 220–240 V, 50/60 Hz, 730–870 W

Automatic toaster TA 3554

- Compact 2-slice toaster
- Cool touch housing
- Bun warmer (removable)
- Defrost/reheat/quick-stop function
- Continuously adjustable browning
- 3 indicator lights (blue illuminated)
- Automatic/manual switch-off
- Crumb drawer
- Cord storage
- 230 V, 50 Hz, 870 W max.

Kettle WK 3556

- Max. capacity 1.7 litre
- Simple handling due to cable-free technology – easy to pour in and out
- Safety hinged lid
- Lime filter (removable)
- On/off switch (blue illuminated)
- Stainless steel heating element
- Automatic/manual switch-off
- External water level indicator
- Base station with cord storage
- Evaporation/overheating protection
- 230 V, 50 Hz, 2200 W

Colour up



Hand blender
SM 3577 => page 37



Multi chopper
MZ 3579 => page 39



Hand mixer
HM 3014 => page 40





Glass kitchen scale

KW 3626 => page 54

Smoothie maker

SM 3593 => page 51



*your
life*



Kettle

WK 3445 => page 20





12

1 cup coffee machine
KA 3356

- 1 cup coffee machine for filter coffee
- Space-saving design (ideal when out and about)
- Includes one ceramic cup
- Permanent nylon filter (removable)
- On/off switch with indicator light
- Automatic power off
- Nonslip tray (removable)

- 220–240 V, 50 Hz, 270–330 W
- W x H x D approx. 130 x 175 x 155 mm

1-cup coffee machine
KA 3450

- „Coffee to go“ – simple, quick, and fresh, with the familiar taste of an aromatic filter coffee
- Ideal for camping, in the office, at home or on the way
- Incl. thermo stainless steel cup with drink opening and heat insulated aroma seal lid
- 300 ml capacity
- Permanent nylon filter (removable)
- Cup fits virtually all standard cup holders
- Rubberized „Soft Touch“ handle
- On/off switch
- Automatic power off
- Indicator light

- 230 V, 50 Hz, 420 W
- W x H x D approx. 165 x 160 x 245 mm

Coffee machine
KA 3555

- For 8–10 cups of coffee (approx. 1,25 litre)
- Anti-drip protection
- Swivel filter
- On/off switch with indicator light (blue illuminated)
- Water level indicator
- Heating plate with automatic switch-off

- 220–240 V, 50/60 Hz, 730–870 W
- W x H x D approx. 165 x 300 x 250 mm



Can also be combined as a suitable breakfast set

● Art. no. 263 155
EAN 4 006 160 631 555 PU 6



● Art. no. 263 215
EAN 4 006 160 632 156 PU 6



○ Art. no. 263 640
EAN 4 006 160 636 406 PU 6
● Art. no. 263 636
EAN 4 006 160 636 369 PU 6





Coffee machine
KA 3552

- For 8–10 cups of coffee (approx. 1.25 litre)
- Anti-drip protection
- Swivel filter
- On/off switch with indicator light
- Water level indicator
- Heating plate with automatic switch-off
- 230 V, 50 Hz, 870 W max.
- WxHxD approx. 165 x 300 x 250 mm

Coffee machine
KA 3473

- For 12–14 cups of coffee (approx. 1.5 litre)
- Anti-drip protection
- Filter holder (removable)
- On/off switch (illuminated)
- Water level indicator
- Heating plate with automatic switch-off
- Cord storage
- 230 V, 50 Hz, 900 W
- WxHxD approx. 190 x 330 x 205 mm

Coffee machine
KA 3575

- For 8–10 cups of coffee (approx. 1.25 litre)
- Stainless steel insert
- Anti-drip protection
- Filter holder (removable)
- On/off switch with indicator light (blue illuminated)
- Water level indicator
- Heating plate with automatic switch-off
- 230 V, 50 Hz, 1000 W
- WxHxD approx. 185 x 310 x 260 mm



Can also be combined as a suitable breakfast set



Can also be combined as a suitable breakfast set

● Art. no. 263 632
EAN 4 006 160 636 314 PU 6

● Art. no. 263 589
EAN 4 006 160 635 898 PU 6
● Art. no. 263 590
EAN 4 006 160 635 904 PU 6
● Art. no. 263 591
EAN 4 006 160 635 911 PU 6

● Art. no. 263 653
EAN 4 006 160 636 536 PU 6





Coffee machine
KA 3562

- For 12–14 cups of coffee (approx. 1.5 litre)
- High-quality stainless steel application
- Anti-drip protection
- Filter holder (removable)
- On/off switch with indicator light (blue illuminated)
- Water level indicator
- Heating plate with automatic switch-off
- 230 V, 50 Hz, 900 W
- WxHxD approx. 180 x 325 x 260 cm

Coffee machine
KA 3558

- For 8–10 cups of coffee (approx. 1.2 litre)
- Stainless steel insert and lid
- Anti-drip protection
- Filter holder (removable)
- On/off switch with indicator light
- Water level indicator
- Heating plate with automatic switch-off
- 230 V, 50 Hz, 900 W
- WxHxD approx. 195 x 335 x 220 mm

NEW! **Coffee machine**
KA 3642

- For 12–14 cups of coffee (approx. 1.5 litre)
- Stainless steel front
- Programmable 24-hour LCD digital timer
- Anti-drip protection
- Filter holder (removable)
- 4 control buttons
- Heating plate with automatic switch-off
- Water level indicator
- 2 indicator lights
- 230 V, 50 Hz, 900 W max.
- WxHxD approx. 180 x 310 x 220 mm



Can also be combined as a suitable kitchen set



Programmable 24-hour LCD digital timer

● Art. no. 263 649
EAN 4 006 160 636 499 PU 4



● Art. no. 263 644
EAN 4 006 160 636 444 PU 4
● Art. no. 263 647
EAN 4 006 160 636 475 PU 4



● Art. no. 263 337
EAN 4 006 160 633 375 PU 4





Coffee machine
KA 3482

- For 15 cups of coffee (approx. 1.7 litre)
- Stainless steel front
- Programmable 24-hour LCD digital timer
- Anti-drip protection
- Filter holder (removable)
- 4 control buttons (illuminated)
- Heating plate with automatic switch-off
- Water level indicator

- 230 V, 50 Hz, 1000 W
- W x H x D approx. 220 x 375 x 240 mm

Coffee machine
KA 3327

- For 8–10 cups of coffee (approx. 1 litre)
- Thermo jug (double-walled)
- Anti-drip protection
- Filter holder (removable)
- On/off switch with indicator light
- Automatic power off
- Water level indicator

- 220–240 V, 50 Hz, 870 W max.
- W x H x D approx. 185 x 340 x 210 mm

Coffee machine with jugs
KA 3328

- 2 jugs for 8–10 cups of coffee each (2 x 1 litre) – double-walled
- Anti-drip protection
- Filter holder (removable)
- On/off switch with indicator light
- Automatic power off
- Water level indicator

- 230 V, 50 Hz, 870 W max.
- W x H x D approx. 185 x 340 x 210 mm



Programmable 24-hour LCD digital timer

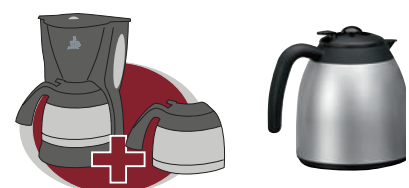

Art. no. 261 665
EAN 4 006 160 616 651

PU 4



Art. no. 263 127
EAN 4 006 160 631 272

PU 6



Art. no. 263 126
EAN 4 006 160 631 265

PU 4





16

Thermo coffee machine KA 3563

- For 8–10 cups of coffee (approx. 1.2 litre)
- Stainless steel thermo jug (double-walled) with aroma seal – drinks remain hot for longer
- High-quality stainless steel application
- Anti-drip protection
- Filter holder (removable)
- On/off switch with indicator light (blue illuminated)
- Automatic power off
- Water level indicator
- 220–240 V, 50 Hz, 800 W
- WxHxD approx. 180 x 325 x 260 cm



Double-walled thermo jug with aroma seal – drinks remain hot for longer

Espresso machine ES 3584

- Espresso and cappuccino pump machine
- Swivelling stainless steel steam nozzle with foaming and hot water function
- Steam volume steplessly adjustable
- Steam nozzle tip removable for easy cleaning
- Cup warming function with aluminum insert
- Constant pump pressure (15 bar)
- 1.5 litre water tank (removable)
- External water level indicator
- Collection cup with aluminum drip grid (removable)
- 2 indicator lights
- Automatic power off
- Ready status indicator
- Accessories: 2 filter holders (1 and 2 cups), coffee measure, tamper
- 230 V, 50 Hz, 1050 W
- WxHxD approx. 185 x 290 x 215 mm



Cup warming function

NEW! Espresso machine ES 3643

- Espresso and cappuccino pump machine
- Stainless steel front
- Swivelling stainless steel steam nozzle with foaming and hot water function
- Steam volume steplessly adjustable
- Steam nozzle tip removable for easy cleaning
- Cup warming function with stainless steel insert
- Constant pump pressure of 15 bar
- 1.6 litre transparent water tank (removable)
- External water level indicator
- Collection cup with stainless steel drip grid (removable)
- 2 indicator lights
- Automatic shut-off
- Operational readiness indication
- Accessories: 2 filter holders (1 and 2 cups), coffee scoop, tamper
- 230 V, 50 Hz, 850 W
- WxHxD approx. 250 x 295 x 280 mm



Cup warming function



Swivelling stainless steel steam nozzle with foaming and hot water function

Art. no. 263 650
EAN 4 006 160 636 505

PU 4



Art. no. 263 671
EAN 4 006 160 100 891

PU 2



Art. no. 263 338
EAN 4 006 160 633 382

PU 2





Stainless steel housing

Cold and warm foaming function

Coffee grinder
KSW 3306

Coffee grinder
KSW 3307

NEW! **Milk frother**
MS 3654

- Electric coffee mill with beater
- Stainless steel beater blade
- Stainless steel bean container, hygienic and with aroma protection
- Transparent lid
- Capacity 40 g – for 20 cups of coffee
- With 120 watt motor
- Safety circuit – operation only possible with lid in place
- Safety pushbutton also for pulsed operation
- Degree of grinding can be selected by the length of operation
- Cord storage

- 230 V, 50 Hz, 120 W
- WxHxD approx. 100 x 200 x 100 mm

- Electric coffee mill with beater
- Stainless steel beater blade
- Stainless steel bean container, hygienic and with aroma protection
- Transparent lid
- Capacity 40 g – for 20 cups of coffee
- With 120 watt motor
- Safety circuit – operation only possible with lid in place
- Safety pushbutton also for pulsed operation
- Degree of grinding can be selected by the length of operation
- Cord storage

- 230 V, 50 Hz, 120 W
- WxHxD approx. 100 x 200 x 100 mm

- Integrated heating function
- Creates foamy milk in seconds
- Also suitable for hot and cold chocolate
- Stainless steel container (880 ml)
- Heat-insulated soft touch casing
- Amount of milk foam: approx. 500 ml
- Simple handling due to cable-free technology, plug connection rotates through 360°
- Electronic – 2 function switch (illuminated)
 - Froth the milk warm
 - Froth the milk cold – ideal for iced coffee
 - Heat the milk
- Built-in heating element
- Automatic switch-off function
- Incl. lid with splash guard function
- Additional stirrer hot drinks without foaming (e.g. cacao)
- Stainless steel container and lid removable for easy cleaning (dishwasher safe)

- 230 V, 50 Hz, 600 W
- WxHxD approx. 105 x 240 x 105 mm

● **Art. no. 283 023**
EAN 4 006 160 830 231 PU 6
● **Art. no. 283 032**
EAN 4 006 160 830 323 PU 6

● **Art. no. 283 024**
EAN 4 006 160 830 248 PU 6

● **Art. no. 263 786**
EAN 4 006 160 637 861 PU 4
● **Art.-Nr. 263 787**
EAN 4 006 160 637 878 PU 4





Cold and warm foaming function



Milk frother MS 3326

- No preheating of the milk thanks to the integrated heating function
 - Creates foamy milk in seconds
 - Also suitable for hot and cold chocolate
 - Mixing container (750 ml)
 - Non-stick coated (inside/outside)
 - Amount of milk foam: approx. 500 ml
 - Simple handling due to cable-free technology, plug connection rotates through 360°
 - Electronic 3 function switch
 - Froth the milk warm
 - Froth the milk cold – ideal for iced coffee
 - Heat the milk
 - Built-in heating element
 - Automatic switch-off function
 - Incl. lid with splash guard function
 - Mixing bowl and lid removable for easy cleaning
- 230 V, 50 Hz, 600 W
 ■ WxHxD approx. 180 x 125 x 175 mm

Milk frother MS 3089

- Creates foamy milk in seconds
 - Soft touch housing
 - Stainless steel whisk
 - Easy to clean
- Battery operation: 2 x 1,5 V AA/UM 3 (batteries not included)
 ■ WxHxD approx. 47 x 225 x 32 mm

Milk frother MS 3502

- Creates foamy milk in seconds
 - Simple handling due to cable-free technology
 - Stainless steel housing
 - Stainless steel frothing whisk
 - Including stainless steel stand and closure cap for practical and hygienic storage
 - LED indicator light (red illuminated)
 - Detachable stainless steel cap (lockable)
- Battery operation: 2x 1.5 V (AA) (batteries not included)
 ■ Length approx. 230 mm; Ø 32 mm



Promotional Packaging

● Art. no. 263 125
 EAN 4 006 160 631 258 PU 4



● Art. no. 262 161
 EAN 4 006 160 621 617 PU 20
 ● Art. no. 263 230
 EAN 4 006 160 632 309 PU 20
 ● Art. no. 263 232
 EAN 4 006 160 632 323 PU 20
 ● Art. no. 263 231
 EAN 4 006 160 632 316 PU 20
 ● Art. no. 263 233
 EAN 4 006 160 632 330 PU 20



● Art. no. 261 674
 EAN 4 006 160 616 743 PU 10





Stainless steel

Travel kettle
WKR 3624

- Ideal when traveling and on the move
- Max. capacity 0.5 litre
- Stainless steel housing
- Incl. 2 cups à 170 ml, transport / travel bag and coffee spoon
- Concealed stainless steel heating element
- Indicator light
- Automatic switch-off
- Evaporation/overheating protection

- 110/230 V, 50 Hz, 1000 W
- WxHxD approx. 160 x 170 x 105 mm

Kettle
WK 3462

- Max. capacity 1.0 litre
- Simple handling due to cable-free technology – easy to pour in and out
- Safety hinged lid with one-handed operation
- Lime filter (removable)
- On/off switch (illuminated)
- Stainless steel heating element
- Automatic/manual switch-off
- 2 external water level indicators
- Rubber profile on the handle
- Incl. base station
- Evaporation/overheating protection

- 230 V, 50 Hz, 900 W
- WxHxD approx. 185 x 220 x 115 mm

Kettle
WK 3445

- Max. capacity 1.7 litre
- Simple handling due to cable-free technology – easy to pour in and out
- Safety hinged lid with one-handed operation
- Lime filter (removable)
- On/off switch (illuminated)
- Stainless steel heating element
- Automatic/manual switch-off
- 2 external water level indicators
- Rubber profile on the handle
- Base station with cord storage
- Evaporation/overheating protection

- 230 V, 50 Hz, 2200 W
- WxHxD approx. 220 x 255 x 140 mm



Incl. transport / travel bag



Incl. 2 cups à 170 ml + coffee spoon

● Art. no. 263 729
EAN 4 006 160 637 298 PU 6

● Art. no. 263 229
EAN 4 006 160 632 767 PU 6
● Art. no. 263 342
EAN 4 006 160 633 429 PU 6

● Art. no. 263 210
EAN 4 006 160 632 101 PU 6
● Art. no. 263 211
EAN 4 006 160 632 118 PU 6
● Art. no. 263 212
EAN 4 006 160 632 125 PU 6





Kettle
WK 3445

- Max. capacity 1.7 litre
 - Simple handling due to cable-free technology – easy to pour in and out
 - Safety hinged lid with one-handed operation
 - Lime filter (removable)
 - On/off switch (illuminated)
 - Stainless steel heating element
 - Automatic/manual switch-off
 - 2 external water level indicators
 - Rubber profile on the handle
 - Base station with cord storage
 - Evaporation/overheating protection
- 230 V, 50 Hz, 2200 W
■ W x H x D approx. 220 x 255 x 140 mm

Kettle
WK 3553

- Max. capacity 1.7 litre
 - Simple handling due to cable-free technology – easy to pour in and out
 - Safety hinged lid
 - Lime filter (removable)
 - On/off switch (illuminated)
 - Stainless steel heating element
 - Automatic/manual switch-off
 - External water level indicator
 - Base station with cord storage
 - Evaporation/overheating protection
- 230 V, 50 Hz, 2200 W
■ W x H x D approx. 220 x 235 x 125 mm

Kettle
WK 3452

- Max. capacity 1.8 litre
 - Simple handling due to cable-free technology – easy to pour in and out
 - 360° connector
 - Lockable safety hinged lid with one-handed operation
 - Lime filter (removable)
 - On/off switch (illuminated)
 - Concealed stainless steel heating element
 - Automatic/manual switch-off
 - 2 external water level indicators
 - Base station with cord storage
 - Overheating protection
- 230 V, 50 Hz, 2200 W
■ W x H x D approx. 225 x 255 x 150 mm



Can also be combined as a suitable kitchen set



Can also be combined as a suitable breakfast set

- **Art. no. 263 672**
EAN 4 006 160 636 727 PU 6
- **Art. no. 263 673**
EAN 4 006 160 636 734 PU 6
- **Art. no. 263 721**
EAN 4 006 160 637 212 PU 6
- **Art. no. 263 674**
EAN 4 006 160 636 741 PU 6



- **Art. no. 263 633**
EAN 4 006 160 636 338 PU 6



- **Art. no. 263 217**
EAN 4 006 160 632 170 PU 6
- **Art. no. 263 227**
EAN 4 006 160 632 279 PU 6





Stainless steel

Kettle
WKS 3576

Kettle
WK 3559

Kettle
WKS 3381

- Max. capacity 1.5 litre
 - Stainless steel insert
 - Simple handling due to cable-free technology – easy to pour in and out
 - 360° connector
 - Lockable safety hinged lid with one-handed operation
 - Lime filter (removable)
 - On/off switch (illuminated)
 - Concealed stainless steel heating element
 - Automatic/manual switch-off
 - 2 external water level indicators
 - Base station with cord storage
 - Evaporation/overheating protection
- 230 V, 50 Hz, 2200 W
■ W x H x D approx. 155 x 245 x 215 mm

- Max. capacity 1.7 litre
 - Simple handling due to cable-free technology – easy to pour in and out
 - 360° connector
 - Safety hinged lid with stainless steel insert and one-handed operation
 - Lime filter (removable)
 - On/off switch
 - Concealed stainless steel heating element
 - Automatic/manual switch-off
 - 2 external water level indicators (illuminated)
 - Base station with cord storage
 - Overheating protection
- 230 V, 50 Hz, 2200 W
■ W x H x D approx. 220 x 235 x 160 mm

- Max. capacity 1.0 litre
 - Stainless steel thermo housing
 - Simple handling due to cable-free technology – easy to pour in and out
 - 360° connector
 - Lockable safety hinged lid
 - Lime filter (removable)
 - On/off switch
 - Concealed stainless steel heating element
 - Automatic/manual switch-off
 - Water level indicator
 - Base station with cord storage
 - Evaporation/overheating protection
- 230 V, 50 Hz, 2200 W max.
■ W x H x D approx. 220 x 195 x 150 mm



Can also be combined as a suitable breakfast set



Can also be combined as a suitable kitchen set

● **Art. no. 263 654**
EAN 4 006 160 636 543 PU 6



● **Art. no. 263 645**
EAN 4 006 160 636 451 PU 4
● **Art. no. 263 648**
EAN 4 006 160 636 482 PU 4



● **Art. no. 263 179**
EAN 4 006 160 631 791 PU 6





Stainless steel



Stainless steel



Stainless steel

Kettle
WKS 3437

- Max. capacity 1.7 litre
- Simple handling due to cable-free technology – easy to pour in and out
- 360° connector
- Lockable safety hinged lid
- Lime filter (integrated)
- On/off switch (illuminated)
- Stainless steel body
- Concealed stainless steel heating element
- Automatic/manual switch-off
- Water level indicator
- Cord storage
- Evaporation/overheating protection
- 220–240 V, 50 Hz, 2000–2400 W max.
- WxHxD approx. 230 x 250 x 145 mm

Kettle
WKS 3288

- Max. capacity 1.7 litre
- Stainless steel thermo housing
- Simple handling due to cable-free technology – easy to pour in and out
- 360° connector
- Lockable safety hinged lid
- Lime filter (removable and washable)
- On/off switch
- Indicator light (blue illuminated)
- Concealed stainless steel heating element
- Automatic/manual switch-off
- 2 external water level indicators
- Base station with cord storage (stainless steel sheathed)
- Evaporation/overheating protection
- 230 V, 50 Hz, 2200 W max.
- WxHxD approx. 220 x 250 x 145 mm

Water kettle
WK 3564

- Max. capacity 1.8 litre
- Simple handling due to cable-free technology – easy to pour in and out
- 360° connector
- Lime filter (removable, washable)
- On/off switch
- Concealed stainless steel heating element
- Stainless steel water jug
- Automatic/manual switch-off
- External water level indicator
- Base station with cord storage
- Evaporation/overheating protection
- 230 V, 50 Hz, 1800 W
- WxHxD approx. 200 x 285 x 230 mm



External water level indicator

- Art. no. 263 567
EAN 4 006 160 635 676 PU 6
- Art. no. 263 568
EAN 4 006 160 635 683 PU 6
- Art. no. 263 569
EAN 4 006 160 635 690 PU 6



- Art. no. 263 553
EAN 4 006 160 625 530 PU 6
- Art. no. 263 090
EAN 4 006 160 630 909 PU 6



- Art. no. 263 651
EAN 4 006 160 632 774 PU 4





Stainless steel

Water kettle
WKS 3625

Electric glass kettle
WK 3501 G

NEW! **Electric glass kettle**
WKS 3641 G

- Max. capacity 1.8 litre
 - Simple handling due to cable-free technology – easy to pour in and out
 - 360° connector
 - Lime filter (removable, washable)
 - On/off switch (illuminated)
 - Concealed stainless steel heating element
 - Stainless steel water jug
 - Automatic/manual switch-off
 - External water level indicator
 - Base station with cord storage
 - Evaporation/overheating protection
- 230 V, 50 Hz, 1850–2200 W
■ WxHxD approx. 245 x 295 x 225 mm

- Max. capacity 1.7 litre
 - Glass/stainless steel housing
 - Water container made of heat resistant safety glass
 - Simple handling due to cable-free technology – easy to pour in and out
 - 360° connector
 - On/off switch
 - Concealed stainless steel heating element
 - Automatic/manual switch-off
 - External water level indicator
 - Base station with cord storage (stainless steel sheathed)
 - Evaporation/overheating protection
- 220–240 V, 50 Hz, 1850–2200 W max
■ WxHxD approx. 220 x 240 x 150 mm

- Max. capacity 1.5 litre
 - Glass/stainless steel housing
 - Lockable stainless steel lid with single-handed operation
 - Water container made of heat-resistant safety glass (blue illuminated)
 - Simple handling due to cable-free technology – easy to pour in and out
 - 360° connector
 - On/off switch
 - Concealed stainless steel heating element
 - Automatic/manual switch-off
 - External water level indicator
 - Base station with cord storage (stainless steel sheathed)
 - Evaporation/overheating protection
- 220–240 V, 50 Hz, 1850–2200 W max.
■ WxHxD approx. 220 x 240 x 130 mm



External water level indicator



Wasser container made of heat-resistant safety glass (blue illuminated)

● **Art. no. 263 727**
EAN 4 006 160 637 274 PU 4
● **Art. no. 263 728**
EAN 4 006 160 637 281 PU 4

● **Art. no. 261 675**
EAN 4 006 160 616 750 PU 4

● **Art. no. 263 336**
EAN 4 006 160 633 368 PU 4





3in1



Stainless steel



24

Tea/coffee station TKS 3504

3 in 1 – tea/coffee station with stainless steel water kettle and tea/coffee maker

Water kettle:

- Max. capacity 1.7 litre
- Stainless steel water kettle with integrated heating element
- Simple handling due to cable-free technology – easy to pour in and out
- 360° connector
- On/off switch
- Lockable safety hinged lid
- Lime filter (integrated)
- Automatic/manual switch-off
- Water level indicator
- Evaporation/overheating protection

Glass jug:

- For tea and coffee making
- Max. capacity 1.2 litre
- Heat-resistant glass
- Stainless steel tea filter (removable)

Base:

- Keep warm function
 - Heating plate (non-stick coated)
 - On/off switch (illuminated)
 - Heat insulated handles
 - Non-slip stand
- 220–240 V, 50 Hz, 2000–2250 W max.
■ W x H x D approx. 410 x 300 x 180 mm

Automatic toaster TA 3565

- Compact 2-slice toaster
 - Cool touch housing
 - Bun warmer (integrated)
 - Defrost/reheat/quick-stop function
 - Continuously adjustable thermostat
 - 2 indicator lights
 - Automatic/manual switch-off
 - Crumb drawer
 - Base station with cord storage
- 220–240 V, 50/60 Hz, 600–700 W
■ W x H x D approx. 285 x 240 x 165 mm

● Art. no. 261 689
EAN 4 006 160 616 897 PU 2



● Art. no. 263 628
EAN 4 006 160 636 284 PU 6
● Art. no. 263 629
EAN 4 006 160 636 291 PU 6
● Art. no. 263 630
EAN 4 006 160 636 307 PU 6





Automatic toaster
TA 3554

- Compact 2-slice toaster
 - Cool touch housing
 - Bun warmer (removable)
 - Defrost/reheat/quick-stop function
 - Continuously adjustable thermostat
 - 3 indicator lights (blue illuminated)
 - Automatic/manual switch-off
 - Crumb drawer
 - Cord storage
- 230 V, 50 Hz, 870 W max.
 - WxHxD approx. 260 x 170 x 145 mm

Automatic toaster
TA 3551

- Compact 2-slice toaster
 - Cool touch housing
 - Bun warmer (removable)
 - Defrost/reheat/quick-stop function
 - Continuously adjustable thermostat
 - 3 indicator lights
 - Automatic/manual switch-off
 - Crumb drawer
 - Cord storage
- 230 V, 50 Hz, 600–700 W. max.
 - WxHxD approx. 260 x 170 x 145 mm

Automatic toaster
TA 3574

- 2-slice toaster
 - Stainless steel insert
 - Cool touch housing
 - Bun warmer (integrated)
 - Defrost/reheat/quick-stop function
 - Continuously adjustable thermostat
 - 3 indicator lights (blue illuminated)
 - Centring function
 - Automatic/manual switch-off
 - Crumb drawer
 - Cord storage
- 230 V, 50 Hz, 850 W
 - WxHxD approx. 300 x 175 x 170 mm



Can also be combined as a suitable breakfast set



Can also be combined as a suitable breakfast set



Can also be combined as a suitable breakfast set

● **Art. no. 263 639**
EAN 4 006 160 636 390 PU 6
● **Art. no. 263 634**
EAN 4 006 160 636 345 PU 6



● **Art. no. 263 631**
EAN 4 006 160 636 321 PU 6



● **Art. no. 263 652**
EAN 4 006 160 636 529 PU 6





Stainless steel housing

**Automatic toaster
TA 3557**

- 2-slice toaster
 - Stainless steel insert
 - Cool touch housing
 - Bun warmer (removable)
 - Defrost/reheat/quick-stop function
 - Continuously adjustable thermostat
 - 3 indicator lights
 - Centring function
 - Automatic/manual switch-off
 - Crumb drawer
 - Cord storage
- 230 V, 50 Hz, 800 W
 - W x H x D approx. 285 x 160 x 170 mm

**Automatic toaster
TA 3620**

- 2-slice toaster
 - Stainless steel housing
 - Bun warmer (removable)
 - Defrost/reheat/quick-stop function (blue illuminated)
 - Continuously adjustable thermostat
 - Centring function
 - Automatic/manual switch-off
 - Crumb drawer
 - Cord storage
- 220–240 V, 50/60 Hz, 750–850 W
 - W x H x D approx. 270 x 180 x 150 mm

**Automatic toaster
TA 3534**

- 4-slice long-slot toaster
 - Heat-insulated cool touch housing
 - Bun warmer (removable)
 - Defrost/reheat/quick-stop function
 - Continuously adjustable thermostat
 - 3 LED indicator lights
 - Automatic switch-off
 - Crumb drawer
 - Cord storage
- 230 V, 50 Hz, 1400 W
 - W x H x D approx. 375 x 175 x 165 mm



Can also be combined as a suitable kitchen set



Defrost/reheat/quick-stop function (blue illuminated)

● **Art. no. 263 643**
EAN 4 006 160 636 437 PU 4

● **Art. no. 263 646**
EAN 4 006 160 636 468 PU 4



● **Art. no. 263 718**
EAN 4 006 160 637 182 PU 4



● **Art. no. 263 614**
EAN 4 006 160 636 147 PU 6





Waffle maker
WA 3491

- Large baking plates: approx. Ø 18 cm (non-stick coated)
- Heat insulated handle
- Continuously adjustable thermostat
- 2 indicator lights for power and heating (baking lights)
- High stability due to rubberized feet
- Overheating protection

- 220–240 V, 50 Hz, 1200 W
- WxHxD approx. 205 x 115 x 250 mm

Waffle maker
WA 3492

- Stainless steel insert
- Large baking plates: approx. Ø 18 cm (non-stick coated)
- Heat insulated handle
- Continuously adjustable thermostat
- 2 indicator lights for power and heating (baking lights)
- Overheating protection

- 230 V, 50 Hz, 1000 Watt
- WxHxD approx. 260 x 100 x 260 mm

Waffle maker
WA 3606

- Waffle maker for Belgian waffles
- Stainless steel insert
- 2 large baking plates, approx 21.5 x 13.5 cm each (non-stick coated)
- 2 waffles for each baking procedure
- Heat insulated handles
- Continuously adjustable thermostat
- 2 indicator lights for power and heating (baking lights)
- High stability due to rubberized feet
- Overheating protection
- Safety shutdown
- Cord storage

- 230 V, 50 Hz, 800 W
- WxHxD approx. 225 x 115 x 200 mm



Stainless steel insert



Stainless steel insert

● Art. no. 261 679
EAN 4 006 160 616 798 PU 6
● Art. no. 261 680
EAN 4 006 160 616 804 PU 6

● Art. no. 261 681
EAN 4 006 160 616 811 PU 4

● Art. no. 271 705
EAN 4 006 160 717 051 PU 4





28

Waffle maker WA 3607

- Stainless steel insert
- 2 large baking plates (non-stick coated)
- 2 waffles for each baking procedure
- Heat insulated handle
- Continuously adjustable thermostat
- 2 indicator lights for power and heating (baking lights)
- High stability due to rubberized feet
- Overheating protection
- Cord storage
- 220–240 V, 50 Hz, 1200 W
- WxHxD approx. 350 x 105 x 230 mm

Ice cream cone maker HA 3494

- Large baking plate: approx. Ø 18 cm (non-stick coated)
- Heat insulated handle
- Continuously adjustable thermostat
- 2 indicator lights for power and heating (baking lights)
- High stability due to rubberized feet
- Incl. squirrel cone
- Overheating protection
- 220–240 V, 50 Hz, 1200 W
- WxHxD approx. 205 x 115 x 250 mm

Crêpe maker CM 3372

- Large baking plate: approx. Ø 29 cm (non-stick coated)
- Paper-thin crêpes, quickly and easily prepared
- Heat-insulated plastic base
- Continuously adjustable thermostat
- 2 indicator lights for power and heating (baking lights)
- Base station with cord storage
- Incl. batter distributor
- 230 V, 50 Hz, 900 W
- WxHxD approx. 325 x 80 x 370 mm



Stainless steel insert



Incl. squirrel cone



Incl. batter distributor

● Art. no. 263 702
EAN 4 006 160 637 021

PU 4



● Art. no. 261 683
EAN 4 006 160 616 835

PU 6



● Art. no. 251 121
EAN 4 006 160 511 215

PU 4





Incl. recipe ideas

Donut maker
DM 3495

- For baking up to 7 bagels/donuts
- Baking surfaces non-stick coated
- Heat insulated handle
- 2 indicator lights for power and heating (baking lights)
- High stability due to rubberized feet
- Overheating protection
- 230 V, 50 Hz, 900 W
- WxHxD approx. 225 x 115 x 225 mm

Muffin maker
MM 3496

- For baking up to 7 muffins
- Muffin diameter approx. 4.5 cm
- Baking surfaces non-stick coated
- Heat insulated handle
- 2 indicator lights for power and heating (baking lights)
- High stability due to rubberized feet
- Overheating protection
- 230 V, 50 Hz, 900 W
- WxHxD approx. 225 x 115 x 225 mm

Cake pop maker
CPM 3529

- For baking up to 13 cake pops
- Baking surfaces non-stick coated
- Heat insulated handle
- 2 indicator lights for power and heating (baking lights)
- High stability due to rubberized feet
- Overheating protection
- Incl. 50 cake pop sticks
- 230 V, 50 Hz, 900 W
- WxHxD approx. 225 x 115 x 225 mm



Incl. 50 cake pop sticks

● **Art. no. 261 684**
EAN 4 006 160 616 842 PU 6



● **Art. no. 261 685**
EAN 4 006 160 616 859 PU 6



● **Art. no. 263 606**
EAN 4 006 160 636 062 PU 6





3in1 Incl. recipe ideas

Donut, muffin & cake pop maker DMC 3533

- Baking up to 12 cake pops, 7 donuts or 7 muffins
 - Baking surfaces non-stick coated and rechargeable
 - Heat insulated handle
 - 2 indicator lights for power and heating (baking lights)
 - High stability due to rubberized feet
 - Overheating protection
 - Locking system
 - Cord storage
 - Incl. 50 cake pop sticks
- 230 V, 50 Hz, 700 W
 ■ WxHxD approx. 208 x 120 x 265 mm



Incl. 50 cake pop sticks



Baking up to 12 cake pops, 7 donuts or 7 muffins

Sandwich toaster ST 3477

- Triangular sandwich plates
 - Non-stick coating
 - Heat insulated handle
 - Automatic temperature controller
 - 2 indicator lights for power and heating (baking lights)
 - Locking system
 - Safety shutdown
 - Overheating protection
- 220–240 V, 50 Hz, 750 W
 ■ WxHxD approx. 230 x 80 x 230 mm

Sandwich toaster ST 3628

- Stainless steel insert
 - Triangular sandwich plates
 - Non-stick coating
 - Heat insulated handle
 - Automatic temperature control
 - 2 indicator lights for power and heating (baking lights)
 - High stability due to rubberized feet
 - Locking system
 - Overheating protection
- 220–240 V, 50/60 Hz, 750 W
 ■ WxHxD approx. 235 x 95 x 235 mm



Stainless steel insert

● **Art. no. 263 613**
 EAN 4 006 160 636 130 PU 4



● **Art. no. 261 658**
 EAN 4 006 160 616 583 PU 6
 ● **Art. no. 261 659**
 EAN 4 006 160 616 590 PU 6
 ● **Art. no. 261 660**
 EAN 4 006 160 616 606 PU 6



● **Art. no. 263 735**
 EAN 4 006 160 637 359 PU 6





Stainless steel housing

3in1

Sandwich toaster
ST 3629

Multi grill
MG 3519

Multi grill
ST/WA 3490

- 4-slice sandwich toaster
- Stainless steel insert
- Triangular sandwich plates
- Non-stick coating
- Heat insulated handle
- Automatic temperature control
- 2 indicator lights for power and heating (baking lights)
- High stability due to rubberized feet
- Locking system
- Overheating protection and overtemperature protection
- 220–240 V, 50/60 Hz, 1200 W
- WxHxD approx. 270 x 105 x 325 mm

- Multi grill for double-sided, fat-free grilling
- 700 watts
- Stainless steel housing
- Short cooking times
- Non-stick grill plates with extra deep grooves for strong grill pattern
- Heat insulated handle
- Indicator light
- Grilling surfaces: 23 x 14.5 cm
- Cord storage
- Versatile, can be used for e.g. panini, steaks, fish or vegetables
- 220–240 V, 50/60 Hz, 700W
- WxHxD approx. 270 x 95 x 230 mm

- Sandwich toaster, waffle maker and contact grill
- Versatile use by three different removable plates (sandwich/waffle/grill plates), e.g. for Belgian waffles and tasty sandwich variations, as well as for fast two-sided contact grilling
- Stainless steel insert
- Baking plates non-stick coated and changeable
- Heat insulated handle
- 2 indicator lights for power and heating (baking lights)
- High stability due to rubberized feet
- Locking system
- Overheating protection
- 230 V, 50/60 Hz, 650 W
- WxHxD approx. 230 x 100 x 225 mm



Stainless steel insert



Stainless steel housing



Stainless steel insert



Sandwich plates, waffle plates, grill plates

Art. no. 263 736
EAN 4 006 160 637 366

PU 4

Art. no. 261 711
EAN 4 006 160 617 115

PU 6

Art. no. 261 678
EAN 4 006 160 616 781

PU 4





32

Ice cube maker EWB 3526

- Compact ice cube maker without complicated installation for producing ice cubes quickly and simply at the press of a button
 - Ideal for home use, in offices, when camping or for small bars
 - No water pipe required, simply fill water into the tank (2.2-l-water tank)
 - Approx. 10–15 kg of ice cubes in 24 hours (approx. 90 g in 10 min – corresponding to 9 ice cubes)
 - LED display and acoustic signal when the ice cube container is full or the water tank is empty
 - Energy-saving mode – automatic switch-off at the end of the program
 - On/off switch
 - 3 indicator lights (ice full, empty water, operation)
 - Visual check through viewing window in the lid
 - Low-noise
- 220–240 V, 50/60 Hz, 150 W
■ WxHxD approx. 245 x 330 x 370 mm



LED displays



For approx. 10–15 kg ice cubes

Ice cream maker ICM 3581

- Ice cream maker for preparing for sorbet, ice cream and frozen yoghurt
 - Double-walled ice cream maker with cold reservoir
 - Transparent lid with refill opening
 - For up to 1500 ml of ice cream
 - Preparation time: 20–40 min.
 - Mixer and motor housing removable for easy cleaning
 - High stability due to rubberized feet
- 220–240 V, 50 Hz, 12 W
■ WxHxD approx. 205 x 230 x 230 mm

NEW! Ice cream maker ICM 3650

- Ice cream maker for preparing for sorbet, ice cream and frozen yoghurt
 - 2 double-walled ice container with cold reservoir, suitable for direct ice consumption
 - Transparent lid with 2 refill openings
 - For up to 2x 500 ml ice cream
 - Preparation time: 15–30 min.
 - Incl. timer (0–45 min.)
 - Mixer and motor housing removable for easy cleaning
 - Incl. recipe suggestions
 - High stability due to rubberized feet
- 220–240 V, 50 Hz, 12 W
■ WxHxD approx. 280 x 230 x 130 mm



2 double-walled ice container with cold reservoir, suitable for direct ice consumption

Art. no. 261 712
EAN 4 006 160 617 122 PU 1



Art. no. 263 663
EAN 4 006 160 636 635 PU 2



Art. no. 263 774
EAN 4 006 160 637 748 PU 4





Soft ice cream maker
ICM 3594

Yoghurt maker
JM 3344

Cotton candy maker
ZWM 3478

- Soft ice cream maker with discharge valve for preparation of soft ice cream, ice cream, frozen yogurt, and sorbet
- Transparent lid with refill opening
- With portioner – ice dispensed directly from the machine
- On/off switch
- Incl. recipe suggestions
- For up to 1000 ml ice cream
- Double-walled ice cream maker with cold storage, removable for easy cleaning (H: 14 cm; Ø 17 cm)
- Stirring element with powerful, quiet motor
- High stability due to rubberized feet
- 220-240 V, 50 Hz, 18 W
- W x H x D approx. 220 x 440 x 225 mm

- Easy preparation of up to 1.1 litres of yoghurt
- 7 practical portion jars with screw cap (capacity: 160 ml)
- On/off switch (illuminated)
- Transparent lid
- Additional jars in a set of 6 also available as an optional EG JM 3344, Product number: 251 125
- 230 V, 50 Hz, 14 W
- W x H x D approx. 240 x 150 x 265 mm

- Large cotton candy bowl: Ø approx. 27 cm
- Transparent splash guard (removable)
- Dish and splash guard dishwasher safe
- Quartz heating element
- High stability due to suction feet
- Including measuring spoon and 10 wooden sticks
- 230 V, 50 Hz, 500 W
- W x H x D approx. 275 x 235 x 275 mm

Suitable replacement jar:
EG JM 3344
Art. no.: 251 125
EAN: 4 006 160 511 253



Soft ice cream maker with discharge valve



Incl. wooden sticks

Art. no. 263 686
EAN 4 006 160 636 864 PU 2

Art. no. 251 119
EAN 4 006 160 511 192 PU 6

Art. no. 261 661
EAN 4 006 160 616 613 PU 4





Stainless steel

Stainless steel

NEW! Popcorn maker
PM 3635

Chocolate fountain
SKB 3248

Egg boiler
EK 3321

- Calorie-conscious popcorn production by hot air (without fat)
 - A healthy and tasty snack for the whole family
 - Quick preparation (2–3 portions in approx. 2 minutes)
 - Easy handling
 - Healthy preparation without oil
 - Incl. portioning tray (for example for butter, corn etc.)
 - Transparent lid
 - On/off switch
- 220–240 V, 50/60 Hz, 1200 W
 - W x H x D approx. 165 x 350 x 180 mm



Easy portioning for example butter, corn etc.

- Chocolate fountain for an exclusive buffet experience
 - Stainless steel housing
 - For dipping in various types of fruit/pastries
 - Extra-smooth cascades for improved flow characteristics
 - Deep drip collection bowl for long-lasting chocolate enjoyment
 - Warm chocolate is transported by means of a worm shaft to the top of the fountain and then flows continuously down the fountain in gentle cascades
 - Height-adjustable feet for a perfectly balanced flow of chocolate
 - Stainless steel tower/fountain
 - Stainless steel drip tray
 - Motor and heating switchable separately by means of 2 switches
 - High stability due to rubberized feet
- 230 V, 50 Hz, 170 W
 - W x H x D approx. 215 x 395 x 215 mm



- Preparation of up to 7 eggs
 - Stainless steel housing
 - Electronic hardness adjuster
 - On/off switch (illuminated)
 - Acoustic signal (buzzer)
 - Removable egg holder
 - Measuring beaker with egg pricker
 - High quality steel hotplate
- 230 V, 50 Hz, 400 W
 - W x H x D approx. 220 x 155 x 185 mm

PREIS-/LEISTUNGSSIEGER	
ETM TESTMAGAZIN - URTEIL	
Clatronic Eierkocher EK 3321	
GUT	86,4 %
Im Test: 4 Eierkocher mit Härtegradregulierung	
Testurteile: 1x sehr gut, 3x gut	
www.etm-testmagazin.de	
Heft 04/2016	

Art. no. 263 335
EAN 4 006 160 633 351 PU 6



Art. no. 262 695
EAN 4 006 160 626 957 PU 4



Art. no. 263 118
EAN 4 006 160 631 180 PU 4





Egg boiler
EK 3497

- Preparation of up to 6 eggs
- Heating dish (non-stick coated)
- On/off switch (illuminated)
- Acoustic signal (buzzer)
- Removable egg holder
- Incl. measuring beaker with egg pricker
- 230 V, 50 Hz, 400 W
- W x H x D approx. 220 x 130 x 135 mm

Pepper/salt mill
PSM 3004 N

- High-quality precision ceramic grinder
- Stainless steel housing
- Adjustable ceramic grinder (from coarse to fine)
- Consistent grinding quality
- Simple refilling
- Single-handed operating
- Incl. light for optimum dosing of the condiment
- Battery-operated
- Battery operation:
4x1,5 V AA/Mignon/LR/AM3 (batteries not included)
- W x H x D approx. 45 x 220 x 45 mm

Food slicer
AS 2958

- Special stainless steel blade (rustproof)
- Powerful motor
- 3 speed level
- Safety power switch
- Infinitely adjustable cutting thickness
- Cutting thickness indication
- Food holder with finger guard
- Removable slide
- Foldable housing
- 220-240 V, 50/60 Hz, 180 W max.
- W x H x D approx. 280 x 230 x 310 mm





Metal food slicer
MA 3585

- Big stainless steel blade (Ø 190 mm), rustproof
 - Universal serrated blade
 - Motor housing: aluminium die cast
 - On/off switch
 - Metal guiding rail
 - Metallic guiding board
 - Food grip with finger protection
 - Continuously adjustable cutting size (0–15 mm)
 - Tilted supporting table with stainless steel insert, tiltable for easy cleaning
 - High stability due to suction feet
- 220–240 V, 50/60 Hz, 150 W
- W x H x D approx. 365 x 235 x 265 mm

PREIS-/LEISTUNGSSIEGER	
ETM TESTMAGAZIN · URTEIL	
Clatronic MA 3585*	
GUT	83,6 %
Im Test: 10 Alleschneider Testurteile: 1x sehr gut, 8x gut, 1x ausreichend www.etm-testmagazin.de	Heft 10/2015
* baugleich mit dem getesteten Modell Bonmann MA 451 CB	



Electric knife
EM 3062

- Serrated stainless steel blades (rustproof, dishwasher-safe)
 - Powerful 180 watt max. motor
 - Low-noise and low-vibration running
 - Safety switch
 - Safety slide switch
- 230 V, 50 Hz, 180 W max.
- W x H x D approx. 420 x 130 x 60 mm

SIEGER PREIS/LEISTUNG	
Haus & Garten Test	(2,4) gut
4/2013	Clatronic EM 3062
www.hausgartentest.de	
Bietet die einfachste Handhabung im Testfeld	

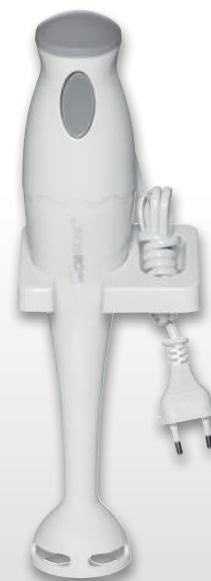

Hand blender
SM 3081

- Stainless steel cutting blade
 - On/off switch (countersunk)
 - Incl. transparent mixing vessel (500 ml)
 - Hanging loop
 - Wall holder plus attachment materials
- 220–240 V, 50 Hz, 180 W
- W x H x D approx. 80 x 330 x 80 mm



Incl. transparent mixing vessel (500 ml)

● Art. no. 263 683
EAN 4 006 160 636 833

PU 2



● Art. no. 262 986
EAN 4 006 160 629 866

PU 6



● Art. no. 262 160
EAN 4 006 160 621 600

PU 12





Incl. transparent mixing vessel

Hand blender
SM 3577

NEW! **Hand blender**
SM 3638

- Stainless steel cutting blade (rustproof)
- On/off switch (countersunk)
- Powerful 180 watt motor
- Incl. transparent mixing vessel (500 ml)
- Hanging loop

- 220–240 V, 50 Hz, 180 W
- WxHxD approx. 80 x 330 x 80 mm

- Soft touch housing
- Stainless steel insert
- 2-level pushbutton switch
- Powerful 600 watt motor
- Stainless steel cutting blade
- Removable stainless steel hand blender
- Ergonomically shaped handle
- Hanging loop

- 220–240 V, 50/60 Hz, 600 W
- WxHxD approx. 65 x 370 x 65 mm



Can also be combined as a suitable kitchen set

- **Art. no. 263 635**
EAN 4 006 160 636 352 PU 8
- **Art. no. 263 638**
EAN 4 006 160 636 383 PU 8
- **Art. no. 263 724**
EAN 4 006 160 637 243 PU 8
- **Art. no. 263 642**
EAN 4 006 160 636 420 PU 8

- **Art. no. 263 766**
EAN 4 006 160 637 663 PU 6



3in1

Hand blender set SMS 3190

- Hand blender set – stainless steel hand blender, multiple chopper and whisk in one
 - Working container with scale (0,5 litre)
 - Powerful 200 watt motor
 - 2 speed level
 - Removable metal whisk
 - Ergonomically shaped rubberized handle for easier handling
 - Holder for metal whisk and stainless steel hand blender
 - Incl. mixing vessel with scale (0.7 litre)
 - Hanging loop
- 220–240 V, 50/60 Hz, 200 W
 - W x H x D approx. 160 x 370 x 150 mm



Multi express ME 3604

- Electrical shredding unit “Multi Express”
 - Large and changeable high-quality drum attachments made of stainless steel, for quick and easy cutting or grating
 - Easy handling
 - 5 functions:
 - cutting (fine/coarse) of, for example, onions, cucumbers
 - grating (fine/coarse) of, for example, carrots, radishes
 - shredding for example of parmesan, nuts, potatoes
 - Powerful 150 W motor
 - Large refill opening (ca. Ø 60 mm)
 - Wide discharge opening (ca. Ø 80 mm)
 - Accessories: 2 cutting attachments (fine/coarse), 2 grating attachments (fine/coarse), 1 shredding attachment
- 220–240 V, 50/60 Hz, 150 W
 - W x H x D approx. 150 x 275 x 230 mm

 Fine cutting
e.g. onions

 Coarse cutting
e.g. cucumbers

 Fine grating
e.g. potatoes

 Coarse grating
e.g. carrots

 Shredding
e.g. parmesan

Art. no. 261 803
EAN 4 006 160 618 037 PU 6



Art. no. 263 701
EAN 4 006 160 637 014 PU 4





2in1 Multi chopper & ice-crusher

2in1 Multi chopper & ice-crusher

2in1 Multi chopper & ice-crusher

Multi chopper
MZ 3579

Multi chopper
MZ 3579

Multi chopper
MZ 3580

- Mixing bowl (1 litre capacity)
- Removable chopping blade (rustproof)
- Incl. ice-crusher function
- Safe base
- Easy to clean

- 220–240 V, 50/60 Hz, 250 W
- W x H x D approx. 175 x 220 x 175 mm

- Mixing bowl (1 litre capacity)
- Removable chopping blade (rustproof)
- Incl. ice-crusher function
- Safe base
- Easy to clean

- 220–240 V, 50/60 Hz, 250 W
- W x H x D approx. 175 x 220 x 175 mm

- Mixing bowl made of glass (1.2 litre capacity)
- Removable chopping blade (stainless steel, rustproof)
- 2-level pulse switching
- Incl. ice-crusher function
- Mixing bowl suitable for microwave oven
- Safe base
- Easy to clean

- 220–240 V, 50/60 Hz, 300 W
- W x H x D approx. 175 x 265 x 175 mm



Can also be combined as a suitable kitchen set

Art. no. 263 662
EAN 4 006 160 636 628 PU 6

- Art. no. 263 675
EAN 4 006 160 636 758 PU 6
- Art. no. 263 676
EAN 4 006 160 636 765 PU 6
- Art. no. 263 723
EAN 4 006 160 637 236 PU 6
- Art. no. 263 677
EAN 4 006 160 636 772 PU 6

Art. no. 263 661
EAN 4 006 160 636 611 PU 6





2in1

Multi chopper & ice-crusher



40

Multi chopper
MZ 3560

- Mixing bowl made of glass (1.2 litre capacity)
- 2 removable chopping blades (stainless steel, rustproof)
- Incl. ice-crusher function
- Mixing bowl suitable for microwave oven
- Stainless steel insert
- Safe base
- Easy to clean

- 220-240 V, 50 Hz, 300 W
- WxHxD approx. 175 x 280 x 175 mm

Hand mixer
HM 3014

- Powerful 250 watt motor
- 5 speed level
- Eject button
- Stainless steel dough hooks and beaters
- All accessories are dishwasher-safe

- 230 V, 50 Hz, 250 W
- WxHxD approx. 180 x 280 x 90 mm

Hand mixer
HM 3014

- Powerful 250 watt motor
- 5 speed level
- Eject button
- Stainless steel dough hooks and beaters
- All accessories are dishwasher-safe

- 230 V, 50 Hz, 250 W
- WxHxD approx. 180 x 280 x 90 mm



Can also be combined as a suitable kitchen set



Can also be combined as a suitable kitchen set

- Art. no. 263 624
EAN 4 006 160 636 246 PU 6
- Art. no. 263 667
EAN 4 006 160 636 673 PU 6



- Art. no. 262 147
EAN 4 006 160 621 471 PU 6



- Art. no. 263 678
EAN 4 006 160 636 789 PU 6
- Art. no. 263 679
EAN 4 006 160 636 796 PU 6
- Art. no. 263 726
EAN 4 006 160 637 267 PU 6
- Art. no. 263 680
EAN 4 006 160 636 802 PU 6





2in1

Hand mixer set
HM 3524

- Powerful 300 watt motor
- 5 speed level
- Turbo setting
- Eject button
- Stainless steel dough hooks and beaters (21 cm) (dishwasher-safe)
- 220–240 V, 50/60 Hz, 300 W
- W x H x D approx. 90 x 145 x 200 mm



2in1

Hand mixer set
HMS 3320

- Powerful 220 watt motor
- 5 speed level
- Turbo setting
- Eject button
- Large mixing bowl, rotating (2.5 litre)
- Accessory: 2 beaters and 2 dough hooks (chrome plated)
- Silent running
- All accessories dishwasher-safe
- 230 V, 50/60 Hz, 220 W
- W x H x D approx. 270 x 330 x 200 mm



Hand mixer set
HMS 2739

- Powerful 250 watt motor
- 5 speed level
- Turbo setting
- High-speed blender attachment
- With fine steel knife, stainless steel beaters and dough hooks
- Large mixing bowl with automatic drive
- All accessories dishwasher-safe
- 230 V, 50/60 Hz, 250 W
- W x H x D approx. 300 x 350 x 200 mm



Incl. quick blender



Incl. quick blender

ETM TESTMAGAZIN · URTEIL	
Clatronic KM3610	
GUT	88,7 %
Im Test: 8 Küchenmaschinen Testurteile: 2x sehr gut, 6x gut www.etm-testmagazin.de	Heft 11/2015



1000 Watt

**Food processor
KM 3610**

**NEW! Food processor
KM 3647**

- Variable electronic speed control + pulse function
 - Electronic timer function
 - 4.2 litre fine steel dish for max. 2–2.5 kg dough preparation
 - Aluminium die-cast stirring hook – also enables the uniform mixing of sizeable quantities of dough
 - Aluminium die-cast dough hook – for heavy doughs, e.g. yeast or bread dough
 - Stainless steel whisk for light sponge cake and fluffy egg whites
 - Constant power through load-dependent, electronic speed control
 - 35° swivelling multifunction arm
 - Unlocking mechanism for multifunction arm
 - Safety circuit
 - Transparent splash protection lid (removable)
 - Particularly easy to operate and clean
 - High stability due to suction feet
 - Base station with cord storage
 - Quick-action chuck for holding the tools
- 220–240 V, 50/60 Hz, 600 W
■ W x H x D approx. 365 x 309 x 220 mm

- High-performance kneading machine with powerful 1000 watt
 - 8 speed level (0-1-2-3-4-5-6 + pulse function)
 - 5 litre fine steel dish for max. 2.5–3 kg dough preparation
 - Aluminium die-cast stirring hook – also enables the uniform mixing of sizeable quantities of dough
 - Aluminium die-cast dough hook – for heavy doughs, e.g. yeast or bread dough
 - Stainless steel whisk for light sponge cake and fluffy egg whites
 - Special robust gear mechanism
 - Constant power through load-dependent, electronic speed control
 - 35° swivelling multifunction arm
 - Unlocking mechanism for multifunction arm
 - Safety circuit
 - Transparent splash protection lid with refill opening (removable)
 - Particularly easy to operate and clean
 - High stability due to suction feet
 - Quick-action chuck for holding the tools
- 220–240 V, 50/60 Hz, 1000 W
■ W x H x D approx. 356 x 309 x 275 mm



● Art. no. 263 704
EAN 4 006 160 637 045 PU 2

● Art. no. 263 783
EAN 4 006 160 637 830 PU 1
● Art. no. 263 788
EAN 4 006 160 637 885 PU 1





ELECTRONIC

1200 Watt



Kneading and stirring machine
KM 3632

- Powerful food processor/kneading machine with extra-powerful 1200 watt max.
 - 5 speed level (0-1-2-3-4)
 - 5 LED indicator lights (blue illuminated)
 - 5.6 litre fine steel dish for max. 2–2.5 kg dough preparation
 - Stainless steel bowl (rustproof)
 - Aluminium die-cast stirring hook – also enables the uniform mixing of sizeable quantities of dough
 - Aluminium die-cast dough hook – for heavy doughs, e.g. yeast or bread dough
 - Whisk made of stainless steel
 - Special robust gear mechanism
 - Electronic speed control
 - 35° swivelling multifunction arm
 - Unlocking mechanism for multifunction arm
 - Safety circuit (can only be operated with the lid in position or with cover)
 - Transparent splash protection lid
 - Particularly easy to operate and clean
 - High stability due to suction feet
-
- 220–240 V, 50 Hz, 1200 W max.
 - W x H x D approx. 390 x 350 x 280 mm



Electronic circuit



35° swivelling multifunction arm

● **Art. no. 263 741**
EAN 4 006 160 637 410

PU 1

● **Art. no. 263 742**
EAN 4 006 160 637 427

PU 1

● **Art. no. 263 743**
EAN 4 006 160 637 434

PU 1





2in1



ELECTRONIC



44

Kneading and stirring machine set KM 3633 W

Kneading and stirring machine set

- Powerful food processor/kneading machine with extra powerful 1200 watts max.
 - 5 speed level (0-1-2-3-4)
 - 5 LED indicator lights (blue illuminated)
 - 5.6 litre fine steel dish for max. 2–2.5 kg dough preparation
 - Stainless steel bowl (rustproof)
 - Aluminium die-cast stirring hook – also enables the uniform mixing of sizeable quantities of dough
 - Aluminium die-cast dough hook – for heavy doughs, e.g. yeast or bread dough
 - Whisk made of stainless steel
 - Special robust gear mechanism
 - Electronic speed control
 - 35° swivelling multifunction arm
 - Unlocking mechanism for multifunction arm
 - Safety circuit (can only be operated with the lid in position or with cover)
 - Transparent splash protection lid
 - Particularly easy to operate and clean
 - High stability due to suction feet
- 220–240 V, 50 Hz, 1200 W max.
 - W x H x D approx. 390 x 350 x 280 mm



Kitchen scale

- Extra-flat digital kitchen scale
- Weighing surface made of high-quality glass
- Clearly legible LCD display
- Weights up to 5 kg (1 g scaling)
- Adjustable measuring units: g, lb-oz, ml, fl-oz
- Automatic switch-off
- On/off switch
- Tare function (additive weighed function)
- High stability due to rubberized feet
- Low battery indicator

- Battery-operated:
1x CR 2032
(battery included)
- W x H x D approx.
150 x 17 x 220 mm



Electronic circuit



35° swivelling multifunction arm



Art. no. 263 745

EAN 4 006 160 637 458

PU 1





NEW! Food processor
KM 3630

- High-performance kneading machine with extra-powerful 1200 watt
 - 8 speed level (0-1-2-3-4-5-6 + pulse function)
 - 6.3 litre fine steel dish for max. 3–3.5 kg dough preparation
 - Aluminium die-cast stirring hook (non-stick coated) – also enables the uniform mixing of sizeable quantities of dough
 - Aluminium die-cast dough hook (non-stick coated) – for heavy doughs, e.g. yeast or bread dough
 - Stainless steel whisk for light sponge cake and fluffy egg whites
 - Special robust gear mechanism
 - 35° swivelling multifunction arm
 - Unlocking mechanism for multifunction arm
 - Safety circuit
 - Transparent splash protection lid with refill opening (removable)
 - Particularly easy to operate and clean
 - High stability due to suction feet
 - Quick-action chuck for holding the tools
- 220–240 V, 50 Hz, 1200 W
 - WxHxD approx. 402 x 326 x 212 mm



35° swivelling
multifunction arm

● **Art. no. 263 739**
EAN 4 006 160 637 397 PU 1

● **Art. no. 263 752**
EAN 4 006 160 637 526 PU 1

● **Art. no. 263 753**
EAN 4 006 160 637 533 PU 1

Incl. glass mixing container with scale and refill opening (1.5 litre capacity)

XXL
fine steel dish
(6.3 litre)



1200 Watt

6.3 litre

2in1



ELECTRONIC



NEW! Food processor
KM 3636

Kneading and stirring machine
incl. meat mincer KM 3414

- High-performance kneading machine with extra-powerful 1200 watt
- 8 speed level (0/1/2/3/4/5/6 + pulse function)
- 6.3 litre stainless steel dish for max. 3–3.5 kg dough preparation
- Glass mixing container with scale and refill opening (1.5 litre capacity)
- Aluminium die-cast stirring hook – also enables the uniform mixing of sizeable quantities of dough
- Aluminium die-cast dough hook – for heavy doughs, e.g. yeast or bread dough
- Stainless steel whisk for light sponge cake and fluffy egg whites
- Special robust gear mechanism
- 35° swivelling multifunction arm with unlocking mechanism
- Safety circuit
- Transparent splash protection lid with refill opening (removable)
- Particularly easy to operate and clean
- High stability due to suction feet
- Quick-action chuck for holding the tools
- 220–240 V, 50 Hz, 1200 W
- W x H x D approx. 402 x 362 x 212 mm



- High-performance kneading machine with powerful 1000 watt
- 6 speed level (1-2-3-4-5-6)
- 7 LED indicator lights (blue illuminated)
- 5 litre fine steel dish for max. 2 kg dough preparation
- Aluminium die-cast stirring hook – also enables the uniform mixing of sizeable quantities of dough
- Aluminium die-cast dough hook – for heavy doughs, e.g. yeast or bread dough
- Stainless steel whisk for light sponge cake and fluffy egg whites
- Special robust gear mechanism
- Electronic speed control
- 35° swivelling multifunction arm with unlocking mechanism
- Safety circuit
- Transparent splash protection lid (removable)
- Particularly easy to operate and clean
- High stability due to suction feet
- Protective cover for drive axle

Mincer

- Stainless steel blades, metal refill tray, metal tube, metal cutter, 3 steel mincing disks (5/3/2 mm)
- Biscuit attachment, sausage filler accessory
- Kebbe attachment – oriental cuisine
- 220–240 V, 50 Hz, 1000 W
- W x H x D approx. 534 x 455 x 234 mm



Art. no. 263 763
EAN 4 006 160 637 632 PU 1



Art. no. 263 670
EAN 4 006 160 636 703 PU 1





Incl. glass mixing container with scale and refill opening (1.5 litre capacity)



Pasta attachments, e.g. for spaghetti, macaroni, penne and tagliatelle



4in1

1000 Watt

NEW! Food processor
KM 3648

- High-performance food processor with powerful 1000 watt
- 8 speed level (0/1/2/3/4/5/6 + pulse function)
- 5 litre fine steel dish for max. 2.5–3 kg dough preparation
- Glass mixing container with scale and refill opening (1.5 litre capacity)
- Aluminium die-cast stirring hook – also enables the uniform mixing of sizeable quantities of dough
- Aluminium die-cast dough hook – for heavy doughs, e.g. yeast or bread dough
- Stainless steel whisk for light sponge cake and fluffy egg whites
- Special robust gear mechanism
- 35° swivelling multifunction arm with unlocking mechanism
- Transparent splash protection lid with refill opening (removable)
- Safety circuit
- Particularly easy to operate and clean
- High stability due to suction feet
- Quick-action chuck for holding the tools



Mincer

- Metal tube, metal cutter, 3 steel mincing disks, stainless steel cutter, sausage filler accessory, biscuit attachment, metal refill tray, attachment for oriental dumplings

Pasta function

- Make pasta yourself with 4 different attachments, e.g. spaghetti, penne, macaroni, tagliatelle

- 220–240 V, 50/60 Hz, 1000 W
- WxHxD approx. 426 x 563 x 230 mm



Accessories: 4 different pasta attachments, metal cutter, metal tube, 3 stainless steel mincing disks, biscuit attachment, sausage filler accessory, kebbe attachment for oriental cuisine



Incl. mincer and pasta function



Glass mixing container with scale and refill opening



7in1

NEW! Food processor
KM 3645

- Powerful kitchen machine with 600 watt
- 4 speed level (0-1-2 + pulse function)
- Mixing vessel with scale and refill opening (1.5 litre capacity)
- Working container with scale and refill opening (1.5 litre capacity)
- Cover for the refill opening can also be used as a measuring beaker (3 cl)
- High-grade, interchangeable attachments from stainless steel for chopping and cutting
- Safety circuit
- Accessories (7in1): Mixing vessel with scale and refill opening (1.5 litre capacity), 1x cutting insert, 1x grating insert, 1x chipping/julienne disc, mixing blade, chopping blade, citrus juicer application, measuring cup (3 cl)
- High stability due to suction feet
- 220-240 V, 50/60 Hz, 600 W
- W x H x D approx. 267 x 385 x 205 mm



Accessories: 1x cutting insert, 1x grating insert, 1x chipping/julienne disc, mixing blade, chopping blade, citrus juicer application



Incl. mixing vessel with scale and refill opening (1.5 litre capacity)



5in1

Stainless steel

NEW! Food processor
KM 3646

- Stainless steel housing
- 4 speed level (0-1-2 + pulse function)
- Mixing vessel with scale and refill opening (1.5 litre capacity)
- Working container with scale and refill opening (1.0 litre capacity)
- Cover for the refill opening can also be used as a measuring beaker (3 cl)
- High-grade, interchangeable attachments from stainless steel for cutting and grating
- Safety circuit
- Accessories (5in1): Mixing vessel with scale and refill opening (1.5 litre capacity), stainless steel cutting/grating insert, mixing blade, chopping blade, measuring cup (3 cl)
- High stability due to suction feet
- 220-240 V, 50 Hz, 500 W
- W x H x D approx. 190 x 370 x 190 mm



Accessories: 1x stainless steel cutting/grating insert, mixing blade, chopping blade



Incl. mixing vessel with scale and refill opening (1.5 litre capacity)

Art. no. 263 782
EAN 4 006 160 637 823 PU 2



Art. no. 263 781
EAN 4 006 160 637 816 PU 2





1000 Watt



1200 Watt



Universal mixer
UM 3470

Mincer
FW 3151

Mincer
FW 3506

- Stainless steel insert
- Metal cutter
- Metal tube
- Metal filling tray
- Stainless steel cutter
- 3 steel disks
- Reverse function
- Pastry attachment
- Sausage filler accessory
- Kebbe attachment – oriental cuisine
- On/off switch
- 220–240 V, 50 Hz, 1000 W max.
- W x H x D approx. 330 x 350 x 195 mm

- Chrome-plated front plate
- Metal neck
- Metal feed tray
- Metal feed screw
- 3 stainless steel discs (7/5/3 mm)
- Stainless steel knife
- Reverse function
- Cookie maker attachment
- Sausage filler accessory
- Kebbe attachment – oriental cuisine
- On/off switch
- High stability due to suction feet
- 220–240 V, 50/60 Hz, 1200 W max.
- W x H x D approx. 330 x 355 x 170 mm

- Universal mixer for pureeing, beating, chopping, shaking and mixing
- Ideal for preparing fruit and fitness drinks, milk shakes, cocktails, soups, salsa sauces, baby food
- Ideal for kitchen and bar
- Ice crush function
- Powerful max. 500 watt motor
- 5 speed level (0-1-2-3-4 + turbo/pulse function)
- Removable mixing bowl (1.5 litre capacity)
- Lid with refill opening
- Cover for the refill opening can also be used as a measuring beaker (2 cl)
- Stainless steel blade (rustproof)
- Safety circuit – operation only possible with vessel in place
- High stability due to rubberized feet
- 220–240 V, 50/60 Hz, 500 W max.
- W x H x D approx. 160 x 400 x 160 mm



Integrated storage compartment for accessories



Incl. 3 steel discs, cookie maker attachment, kebbe attachment, sausage filler accessory



Incl. 3 stainless steel discs, cookie maker attachment, kebbe attachment, sausage filler accessory

Art. no. 263 315
EAN 4 006 160 633 153 PU 4



Art. no. 261 691
EAN 4 006 160 616 910 PU 4



Art. no. 263 583
EAN 4 006 160 635 836 PU 4





2in1

Universal mixer UM 3561

- Universal mixer for pureeing, beating, chopping, shaking and mixing
 - Ideal for preparing fruit and fitness drinks, milk shakes, cocktails, soups, salsa sauces, baby food
 - Ideal for kitchen and bar
 - Stainless steel front
 - Incl. ice-crusher function
 - Powerful 600 watt motor
 - 4 level switch (0-1-2 + pulse/turbo function)
 - Removable mixing bowl made of solid glass with scale (1.5 litre capacity)
 - Lid with refill opening
 - Cover for the refill opening can also be used as a measuring beaker (5 cl)
 - 4-fold stainless steel blade (rustproof)
 - Safety circuit – operation only possible with vessel in place
 - Knife block removable for cleaning
 - High stability due to rubberized feet
- 220–240 V, 50/60 Hz, 600 W
■ WxHxD approx. 185 x 410 x 200 mm



Can also be combined as a suitable kitchen set



2in1

Stainless steel

Universal mixer UM 3284

- Stainless steel universal mixer for pureeing, beating, chopping up, shaking and mixing
 - Ideal for preparing fruit and fitness drinks, milk shakes, cocktails, soups, salsa sauces, baby food
 - Ideal for kitchen and bar
 - Stainless steel housing
 - Ice-crusher function
 - Powerful max. 650 watt motor
 - 4 speed level (0-1-2 + pulse function)
 - Rotary switch (blue illuminated)
 - Removable mixing vessel made of solid glass with 1.5 litre capacity (with scale)
 - Lid with refill opening
 - Cover for the refill opening can also be used as a measuring beaker (2 cl)
 - 6-fold stainless steel blade (rustproof)
 - Safety circuit – operation only possible with vessel in place
 - All accessories are dishwasher-resistant
 - Knife block removable for cleaning
 - High stability due to rubberized feet
 - Cable storage compartment in the base section
- 220–240 V, 50/60 Hz, 650 W max.
■ WxHxD approx. 200 x 410 x 185 mm

● Art. no. 263 625
EAN 4 006 160 636 253 PU 4
● Art. no. 263 668
EAN 4 006 160 636 680 PU 4



● Art. no. 263 115
EAN 4 006 160 631 159 PU 4





Stainless steel



Mixing cup also suitable as drinking cup

2in1

NEW! Universal mixer
UM 3644

Smoothie maker
SM 3593

- Stainless steel universal mixer for pureeing, beating, chopping up, shaking and mixing
- Ideal for preparing fruit and fitness drinks, milk shakes, cocktails, soups, salsa sauces, baby food
- Ideal for kitchen and bar
- Stainless steel housing
- Ice-crusher function
- Powerful 650 watt motor
- 4 speed level (0-1-2-3-4 + pulse function)
- Removable mixing vessel made of solid glass with 1.5 litre capacity (with scale)
- Lid with refill opening
- Cover for the refill opening can also be used as a measuring beaker (6.5 cl)
- 4-fold stainless steel blade with „piranha“ cut for easy mixing (rustproof)
- Safety circuit – operation only possible with vessel in place
- High stability due to rubberized feet

- 220–240 V, 50/60 Hz, 650 W
- WxHxD approx. 177 x 400 x 175 mm

- Universal mixer for pureeing, beating, chopping up, shaking and mixing, consisting of base, mixing cup and lid with drinking aperture
- “Mix & Go” – Mix your favorite shake in a few minutes. With the practical drinking aperture, you can take your freshly prepared shake with you to work, school or sports
- Ideal for preparing fruit and fitness drinks, milk shakes, cocktails, soups, salsa sauces, baby food
- Incl. recipe suggestions
- Incl. lid with drinking aperture
- Ideal for kitchen, bar and on the road
- Powerful motor, 250 W
- 1 speed (pulse function)
- Detachable mixing container (600 ml)
- Stainless steel blade (rustproof)
- Safety circuit – operation only possible with vessel in place
- All accessories dishwasher safe
- High stability due to rubberized suction pads

- 220–240 V, 50 Hz, 250 W
- WxHxD approx. 130 x 370 x 125 mm



Replacement bottle for
Smoothie maker EF SM 3593

● Art. no. 264 559
EAN 4 006 160 645 590 VE 6

● Art. no. 263 780
EAN 4 006 160 637 809 PU 4



● Art. no. 263 480 PU 6
EAN 4 006 160 634 808
● Art. no. 263 688 PU 6
EAN 4 006 160 636 888
● Art. no. 263 689 PU 6
EAN 4 006 160 636 895



● Art. no. 263 722 PU 6
EAN 4 006 160 637 229
● Art. no. 263 690 PU 6
EAN 4 006 160 636 901



Bar mixer / milk frother
BM 3472

- Bar mixer and milk frother
- Attractive chrome design
- Ideal for preparing fruit and fitness drinks, milk shakes, cocktails, salsa sauces, baby food
- Ideal for bar and kitchen
- Powerful 65 watt motor
- 2 speed level
- Stainless steel cup with a capacity up to 650 ml
- Convenient cup holder with safety circuit
- Stainless steel blender
- High stability due to rubberized feet
- 230 V, 50 Hz, 65 W
- WxHxD approx. 135 x 370 x 175 mm



Incl. practical cup holder



Citrus fruit squeezer
ZP 3066

- Removable bowl with aroma protective cover (1.2 litre)
- 2 press cones
- Automatic start/stop function by pressing juicer cone
- Automatic clockwise/anticlockwise operation for optimal juice extraction
- Practical cable tidy
- 230 V, 50 Hz, 40 W
- WxHxD approx. 180 x 230 x 180 mm



Citrus fruit squeezer
ZP 3253

- 2 press cones
- Automatic start/stop function by pressing juicer cone
- Automatic clockwise/anticlockwise operation for optimal juice extraction
- Unobstructed juice outflow
- Anti drip function
- 220–230 V, 50 Hz, 25 W
- WxHxD approx. 155 x 210 x 155 mm

● Art. no. 263 585
EAN 4 006 160 635 850

PU 6



● Art. no. 262 988
EAN 4 006 160 629 880

PU 6



● Art. no. 263 077
EAN 4 006 160 630 770

PU 6





Stainless steel

Automatic juicer
AE 3531

- Powerful 400 watt max.
- Fresh fruit and vegetable juices quickly prepared.
Rich in vital substances for well-being, fitness and health
- 30 % more juice and vitamins
- Removable pulp container
- Removable juice container
- On/off switch
- Lock with safety switch
- Stainless steel micro-strainer for finest juices
- Can be completely taken apart for rapid and unproblematic cleaning
- Safe stand

- 220–240 V, 50 Hz, 350–400 W max.
- W x H x D approx. 235 x 330 x 210 mm

Professional automatic juicer
AE 3532

- Professional automatic juicer in high-quality stainless steel housing
- Fresh fruit and vegetable juices quickly prepared.
Rich in vital substances for well-being, fitness and health
- 30 % more juice and vitamins
- Extra large filler spout (75 mm Ø)
- Extracts the juice from apples, carrots and other fruits within seconds without having to chop them
- Powerful 1000 watt motor max.
- 3 speed level (0-1-2) for different fruit hardness
- High volume pulp container (approx. 2.0 litre capacity)
- Open stainless steel juice spout
- Flexible anti-drip juice spout – no splashes and no wiping
- Lock with safety switch
- Stainless steel sieve for finest juices
- Can be completely disassembled – quick and easy cleaning
- High stability

- 230 V, 50 Hz, 1000 W max.
- W x H x D approx. 300 x 400 x 220 mm



Stainless steel

Stainless steel

Glass kitchen scale
KW 3626

Kitchen scale
KW 3367

Kitchen scales
KW 3412

- Extra-flat digital kitchen scale
- Weighing surface made of high-quality glass
- Clearly legible LCD display
- Weights up to 5 kg (1 g scaling)
- Adjustable measuring units: g, lb-oz, ml, fl-oz
- Automatic switch-off
- On/off switch
- Tare function (additive weighed function)
- High stability due to rubberized feet
- Low battery indication

- Battery-operated: 1 x CR 2032 (battery supplied)
- W x H x D approx. 150 x 17 x 220 mm

- Extra-flat digital kitchen scale
- Weighing surface made of stainless steel
- Clearly legible LCD display
- Weights up to 5 kg (1 g scaling)
- Adjustable measuring units: kg, g, lb, oz
- Automatic switch-off
- On/off switch
- Tare function (additive weighed function)

- Battery-operated: 2 x AAA (batteries not supplied)
- W x H x D approx. 150 x 20 x 180 mm

- Extra-flat digital kitchen scale
- Weighing surface made of stainless steel
- Clearly legible LCD display (blue illuminated)
- Weights up to 5 kg (1 g scaling)
- Adjustable measuring units: kg, g, lb, oz
- Automatic switch-off
- On/off switch
- Tare function (additive weighed function)
- Hanging loop (blue illuminated)

- Battery-operated: 3 x AAA (batteries supplied)
- W x H x D approx. 170 x 15 x 230 mm



Can also be combined as a suitable kitchen set

- Art. no. 263 730 PU 6
EAN 4 006 160 637 304
- Art. no. 263 734 PU 6
EAN 4 006 160 637 311
- Art. no. 263 733 PU 6
EAN 4 006 160 637 328
- Art. no. 263 732 PU 6
EAN 4 006 160 637 328

- Art. no. 271 667 PU 6
EAN 4 006 160 716 672
- Art. no. 271 680 PU 6
EAN 4 006 160 716 801





Stainless steel



Kitchen scale
KW 3416

Food dryer
DR 2751

Food dryer
DR 3525

- Extra-flat digital kitchen scales with permanent clock and temperature information
- Stainless steel weighing surface
- Clearly legible, high-quality multifunction LCD display
- Weights up to 5 kg (1 g scaling)
- Adjustable measuring units: kg, g, lb, oz
- Automatic switch-off for weighing function
- On/off switch
- Tare function (additive weighed function)

- Battery-operated: 3 x AAA (batteries supplied)
- W x H x D approx. 160 x 18 x 230 mm

- Food dryer dries fruit, vegetables, herbs, meat etc. Rich in essential minerals for well-being, fitness and health
- Variable use through 5 stackable level
- Circulating air blower, circulating air function
- On/off switch
- Overheating protection

- 230 V, 50 Hz, 250 W
- W x H x D approx. 285 x 160 x 315 mm

- Food dryer dries fruit, vegetables, herbs, meat etc. Rich in essential minerals for well-being, fitness and health
- 2 temperature stages
- Variable use by 5 large, transparent, and stackable level (easy cleaning)
- Circulation fan, air circulation function
- Overheating protection

- 230 V, 50 Hz, 300 W
- W x H x D approx. 330 x 315 x 327 mm



5 stackable level



Variable use by 5 large, transparent, and stackable level (easy cleaning)

Art. no. 271 683
EAN 4 006 160 716 832

PU 6

Art. no. 261 767
EAN 4 006 160 617 672

PU 4

Art. no. 261 699
EAN 4 006 160 616 996

PU 4





56

Can opener DO 2852

- Ergonomically shaped handle
- One-hand operation
- Flexible magnet holder for lid of tin
- Removable blade
- Hanging loop
- 230 V, 50 Hz, 25 W
- WxHxD approx. 210 x 90 x 110 mm

Can opener DO 3627

- Flexible magnet holder for lid of tin
- Suitable for cans of up to max. 19 cm height
- Automatic start/stop function
- Detachable blade (easy cleaning)
- Inclusive:
 - Bottle opener
 - Blade sharpener (ceramic)
- Cord storage
- Secure stand
- 220–240 V, 50/60 Hz, 80 W
- WxHxD approx. 135 x 230 x 115 mm

Bag sealer FS 3261

- Ideal for dividing food into portions
- Electronically controlled bag sealer
- Seals and separates in one operation
- Strong extraction pump
- With bag storage view window
- 2 indicator lights
- Cord storage in base
- Incl. a roll of film (3 m)
- 230 V, 50 Hz, 100 W
- WxHxD approx. 330 x 80 x 125 mm

Spare rolls:

Art. no.	282 020	
EAN	4 006 160 820 201	PU 10
Art. no.	8900 216	
EAN	4 006 160 900 217	PU 10



Integrated bottle
opener



Integrated knife
sharpener (ceramic)



● Art. no. 262 894
EAN 4 006 160 628 944 PU 6



● Art. no. 263 737
EAN 4 006 160 637 373 PU 6



● Art. no. 263 083
EAN 4 006 160 630 831 PU 6





2in1



Removable oil container

Fondue deep fat pan
FFR 2916

Deep fat fryer
FR 3390

Deep fat fryer
FR 3548

- Cool touch housing
- Capacity: 1 litre oil/frying fat
- Deep frying basket with removable handle
- Continuously variable thermostat
- Control panel with display
- 6 fondue forks marked in colour
- Protective ring against spray/fork holder
- Changeable odour and fumes filter
- Overheating protection

- 230 V, 50 Hz, 900 W
- W x H x D approx. 190 x 240 x 190 mm

- Cool touch housing
- Capacity: approx. 2 litre oil/frying fat
- Oil container with non-stick coating
- Large frying basket, can be raised and lowered with the lid closed
- Pop-up lid with viewing window (detachable)
- On/off switch (0-1)
- Continuously adjustable thermostat with indicator light (130°C–190°C)
- 2 indicator lights for power and heating
- Changeable odour and fumes filter
- Collecting container for condensation
- 2 recessed grips for safe transport

- 230 V, 50 Hz, 1800 W
- W x H x D approx. 245 x 260 x 320 mm

- Cool touch housing
- Capacity: 3 litre of oil/frying fat
- Removable oil container (non-stick coated)
- Large frying basket (can be raised or lowered with the lid closed)
- Pop-up lid with viewing window
- Continuously adjustable thermostat (130°C–190°C)
- 30 minute timer with shut-off signal
- 2 indicator lights for temperature/operation
- Changeable odour and fumes filter
- Cable rewind

- 230 V, 50 Hz, 2000 W
- W x H x D approx. 260 x 260 x 420 mm



Art. no. 282 232
EAN 4 006 160 822 328

PU 4



Art. no. 263 180
EAN 4 006 160 631 807

PU 2



Art. no. 283 045
EAN 4 006 160 830 453

PU 2





Stainless steel

58

NEW! Deep fat fryer
FR 3649

- Stainless steel applications
- Capacity: 2.5 litre of oil/frying fat
- Oil container (non-stick coated)
- Pop-up lid with viewing window (removable)
- Continuously adjustable thermostat (130°C-190°C)
- 2 indicator lights for temperature/operation
- Odour and fumes filter
- Drip tray
- Carrying handles (heat-insulated)
- Overheating protection

- 230 V, 50 Hz, 1600 W
- WxHxD approx. 310 x 230 x 310 mm

Stainless steel deep fat fryer
FR 3586

- Housing, lid, heating coil made of stainless steel
- Cool zone technology – heating coils immersed directly in the oil for rapid heating and for odorless frying
- Capacity: 3 litre of oil/frying fat
- Continuously adjustable thermostat with indicator light
- Removable fat container (enamelled)
- Stainless steel heating coil (removable)
- Drip tray
- Carrying handles (heat-insulated)
- Cord storage
- Overheating protection

- 230 V, 50 Hz, 2000 W
- WxHxD approx. 215 x 240 x 405 mm

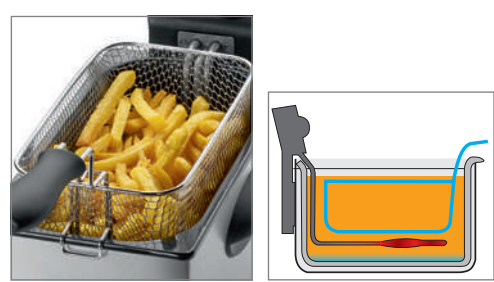

● Art. no. 263 773
EAN 4 006 160 637 731 PU 2
CE

● Art. no. 263 684
EAN 4 006 160 636 840 PU 2
CE

PREIS-/LEISTUNGSSIEGER	
ETM TESTMAGAZIN · URTEIL	
Clatronic FR 3587	
GUT	88,5 %
Im Test: 8 Kaltzonen-Fritteusen Testurteile: 1x sehr gut, 7x gut www.etm-testmagazin.de	Heft 03/2016



Stainless steel

Stainless steel

Stainless steel deep fat fryer
FR 3587

Double deep fat fryer
FR 3195

- Housing, lid, heating coil and grease trap made of stainless steel
 - Cool zone technology – heating coils immersed directly in the oil for rapid heating and for odorless frying
 - Capacity: 3 litre of oil/frying fat
 - Continuously adjustable thermostat with indicator light
 - Lid with viewing window
 - Stainless steel grease trap (removable)
 - Stainless steel heating coil (removable)
 - Drip tray
 - Carrying handles (heat-insulated)
 - Changeable odour and fumes filter
 - Cord storage
 - Overheating protection
- 230 V, 50 Hz, 2000 W
■ WxHxD approx. 215 x 240 x 405 mm

- Professional double deep fat fryer with 2 small baskets and one large frying basket for various types of food
 - Housing, lid, heating coil made of stainless steel
 - Cool-zone technology – heating element directly in the fat for rapid heating and low-odour deep fat frying
 - Capacity: 4 litre of oil/frying fat
 - Removable fat container (enameled)
 - Splash guard lid with filter
 - Continuously adjustable thermostat up to 190°C
 - 2 indicator lights for power and heating
 - Overheating protection
- 230 V, 50 Hz, 2x2000 W
■ WxHxD approx. 227 x 375 x 385 mm

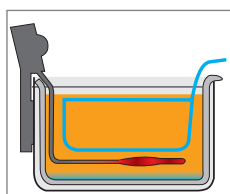

Stainless steel grease trap (removable)

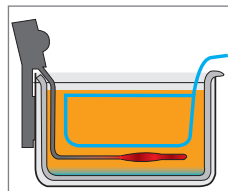

Art. no. 263 685
EAN 4 006 160 636 857 PU 2

Art. no. 273 531
EAN 4 006 160 735 314 PU 2





2in1

Rice cooker
RK 3566

- Rice cooker and steam cooker in one
 - Rice cooker for easy preparation and keeping warm all types of rice, pulses, soups, cereals
 - Additional aluminium steamer insert for vitaminretaining steam cooking of e.g. vegetables, potatoes and fish
 - Safety glass lid with steam outlet
 - Removable pot (non-stick coating)
 - For max. 1300 g of rice (uncooked weight) yields approximately 2500 g cooked rice
 - Automatic keep warm mode when cooking has finished
 - Automatic switch-off (energy-saving)
 - On/off switch
 - Cool touch handles
 - Removable supply cable
 - Safety function: can only be switched on when pot is in position
 - 3 indicator lights for cooking, keeping warm and mains
 - Accessories: measuring beaker (160 ml max.), rice spoon
- 220–240 V, 50 Hz, 700 W
■ WxHxD approx. 310 x 310 x 260 mm



Incl. aluminium steamer insert

Art. no. 263 235
EAN 4 006 160 632 354 PU 2

CE



2in1

Stainless steel

Rice cooker
RK 3567

- Rice cooker and steam cooker in one
 - Rice cooker for easy preparation and keeping warm all types of rice, pulses, soups, cereals
 - Stainless steel housing
 - Additional aluminium steamer insert for vitaminretaining steam cooking of e.g. vegetables, potatoes and fish
 - Safety glass lid with steam outlet
 - Removable pot (non-stick coating)
 - For max. 1300 g of rice (uncooked weight) yields approximately 2500 g cooked rice
 - Automatic keep warm mode when cooking has finished
 - Automatic switch-off (energy-saving)
 - On/off switch
 - Cool touch handles
 - Removable supply cable
 - Safety function: can only be switched on when pot is in position
 - 3 indicator lights for cooking, keeping warm and mains
 - Accessories: measuring beaker (160 ml max.), rice spoon
- 220–240 V, 50 Hz, 700 W
■ WxHxD approx. 310 x 310 x 260 mm



Incl. aluminium steamer insert

Art. no. 263 236
EAN 4 006 160 632 361 PU 2

CE

ETM TESTMAGAZIN - URTEIL	
Clatronic RK 3567	
GUT	87,9 %
Im Test: 9 Reiskocher Testurteile: 1x sehr gut, 8x gut www.etm-testmagazin.de	
Heft 08/2015	



Jam/marmelade program



Wholemeal program



Stainless steel



Jam/marmelade program



Wholemeal program

Bread maker BBA 3505

- Fully automatic dough and bread preparation (kneading, rising, baking)
- Non-stick coated baking form (removable)
- 2 litre capacity (corresponds to about 1000 g bread)
- 12 baking programs / 39 available settings
- Programs: Normal, french, whole wheat, fast baking, sweet, ultra fast baking I, ultra fast baking II, dough, jam, cake, sandwich, baking
- Extra bake function
- Warming function
- Electronic control panel with backlight LCD display
- 13 hour timer
- Variably settable dough quantity
- Variable crust browning control (light, medium, dark)
- Cool touch housing
- Lid with viewing window (removable)
- 230 V, 50 Hz, 600 W
- W x H x D approx. 405 x 305 x 265 mm

Bread maker BBA 3365

- Fully automatic dough and bread preparation (kneading, rising, baking)
- Non-stick coated baking form (removable)
- 2 litre capacity (corresponds to about 1000 g bread)
- 11 baking programs / 34 possible combinations
- Programs: Normal, french, whole wheat, fast baking, sweet, dough, jam, cake, sandwich, baking, kneading
- Warming function
- Electronic control panel with LCD display and audible signal (blue illuminated)
- 13 hour timer
- Variably settable dough quantity
- Variable crust browning control (light, medium, dark)
- Lid with viewing window (removable)
- 230 V, 50 Hz, 700 W
- W x H x D approx. 360 x 305 x 255 mm



Electronic control panel with LCD-Display



2in1 Hot dog maker & egg boiler

Steam cooker
DG 3235

- Steam cooker for the healthy cooking of food without burning vitamins
- 3 steam cooker containers (1 lid, 1 rise bowl)
- Semi-transparent water tank (1.6 litre)
- Drip bowl for the collection of juices
- 60 minute timer
- Water replenishable during operation
- Water level indicator
- Easy to clean
- Overheating protection
- 230 V, 50 Hz, 750 W max.
- WxHxD approx. 300 x 420 x 210 mm

Steam cooker
DG 3547

- Steam cooker for the healthy cooking of food without burning vitamins
- Water-inflow-control – faster steam generation
- 3 steam cooker containers, 1 lid, 1 rise bowl
- High-grade steel base
- Programmable digital timer
- Incl. LCD display (blue illuminated)
- Incl. power control light
- Drip pan for collecting liquids
- Water level indicator
- Add more water during operation
- Easy to clean
- Overheating protection
- 220–240 V, 50/60 Hz, 700–800 W
- WxHxD approx. 310 x 445 x 240 mm

Hot dog maker
HDM 3420 EK N

- Hot dog maker and egg boiler in one
- For 1 to 14 small sausages (e.g. “Frankfurter”, “Vienna sausages”)
- Heated stainless steel skewer
- Preparation of up to 6 eggs
- Removable egg holder
- Transparent steam tank (removable)
- Non-stick coated water bowl
- 2 separate switches for spike and steamer (blue illuminated)
- Incl. measuring cup with egg pricker
- 230 V, 50 Hz, 380 W
- WxHxD approx. 235 x 270 x 160 mm



High-grade steel base incl. LCD display / timer with backlight



Art. no. 251 109
EAN 4 006 160 511 093 PU 4



Art. no. 283 044
EAN 4 006 160 830 446 PU 2



Art. no. 251 136
EAN 4 006 160 511 369 PU 6





Stainless steel

Stainless steel

Ceramic coated

180° opening

Contact grill
KG 3487

Contact grill
KG 3571

- Contact grill for double-sided, fat-free grilling
- Fat drainage channel and drip tray (tray removable for easy cleaning)
- 2000 watts
- Stainless steel housing
- Continuously adjustable thermostat
- Short cooking times
- Non-stick grill plates with extra deep grooves for strong grill pattern and smooth fat drainage
- Large, heat-insulated handle
- 2 indicator lights for power supply and heating
- Temperature "ready" display
- Large grill area: approx. 29.5 x 23.5 cm
- Cord storage
- Versatile, can be used for e.g. panini, steaks, fish or vegetables

- 220–240 V, 50/60 Hz, 2000 W
- W x H x D approx. 335 x 145 x 330 mm

- Contact grill for double-sided, fat-free grilling
- Barbecue grill – 180° opening enables grilling on a large surface
- Fat drainage channel and drip tray (tray removable for easy cleaning)
- 2000 watt
- Stainless steel housing
- Continuously adjustable thermostat
- Short cooking times
- Scratch-resistant, ceramic coated grill plates with extra deep grooves for strong grill pattern and optimal fat runoff
- Large, heat-insulated handle
- 2 indicator lights for power supply and heating
- Temperature "ready" display
- Large grill areas: 2x approx. 29.5 x 23.5 cm
- Cord storage
- Versatile, can be used for e.g. panini, steaks, fish or vegetables

- 220–240 V, 50/60 Hz, 2000 W
- W x H x D approx. 356 x 145 x 336 mm



Stainless steel housing



Scratch resistant ceramic coating



Stainless steel housing



Barbecue grill – 180° opening enables grilling on a large surface

Stiftung Warentest
test
+
GUT (2,4)
Im Test:
9 Kontaktgrills
6 x gut
2 x befriedigend
1 x ausreichend
Ausgabe
06/2015
www.test.de
15T220

Art. no. 261 670
EAN 4 006 160 616 705 PU 3

Art. no. 263 657
EAN 4 006 160 636 574 PU 3





64

Teppanyaki grill TYG 3608

- Japanese-style grilling at the table (healthy and low in calories)
 - Fat-free, odourless and clean
 - Ideal for roasting, cooking and braising fish, meat and vegetables
 - Continuously adjustable thermostat
 - Non-stick coated plate retains and distributes the heat perfectly (easy to clean)
 - Grill area: approx. 45 x 25 cm
 - Drainage channel for excess fat
 - Removable drip tray (easy-to-clean)
 - Heat-insulated carrying handles
 - Safe base
- 230 V, 50 Hz, 2000 W
- WxHxD approx. 542 x 127 x 247 mm

Party pan PP 3401

- Party pan for cooking, roasting, steaming, defrosting and with keep warm function
 - Quick heating and long keep warm function
 - Removable supply line with continuously adjustable thermostat
 - Anti-stick pan for easy cleaning
 - Ø 32 cm, depth: 3.5 cm
 - Heat-resistant glass lid with handle
 - Heat-insulated carrying handles
- 220–240 V, 50/60 Hz, 1500 W
- WxHxD approx. 380 x 160 x 400 mm



Removable drip tray (easy-to-clean)

Removable thermostat

● Art. no. 263 706
EAN 4 006 160 637 069

PU 4



● Art. no. 251 129
EAN 4 006 160 511 291

PU 4





Ceramic coated

Party pan
PP 3401 C

- Party pan for cooking, roasting, steaming, defrosting and with keep warm function
- Quick heating and long keep warm function
- Removable supply line with continuously adjustable thermostat
- Ceramic coated pan (scratch-proof and easy to clean)
- Ø 32 cm, depth: 3.5 cm
- Heat-resistant glass lid with handle
- Heat-insulated carrying handles

- 220–240 V, 50/60 Hz, 1500 W
- WxHxD approx. 380 x 160 x 400 mm

Party pan
PP 2914

- Party pan for cooking, roasting, steaming, defrosting and with keep warm function
- Quick heating and long keep warm function
- Removable supply line with continuously adjustable thermostat
- Non-stick coated pan (easy to clean)
- Ø 38 cm, depth: 4 cm
- Heat-resistant glass lid with handle
- Heat-insulated carrying handles

- 220–240 V, 50 Hz, 1400 W
- WxHxD approx. 450 x 140 x 400 mm



Scratch resistant ceramic coating

● Art. no. 263 655
EAN 4 006 160 636 550

PU 2



● Art. no. 251 102
EAN 4 006 160 511 024

PU 2





Ceramic coated

Party pan
PP 3570 C

- Party pan for cooking, roasting, steaming, defrosting and with keep warm function
- Quick heating and long keep warm function
- Removable supply line with continuously adjustable thermostat
- Ceramic coated pan (scratch-proof and easy to clean)
- Ø 42 cm, depth: 9 cm
- Heat-resistant glass lid with handle
- Heat-insulated carrying handles

- 220–240 V, 50/60 Hz, 1500 W
- WxHxD approx. 430 x 145 x 490 mm

Party pan
PP 3410

- Party pan for cooking, roasting, steaming, defrosting and with keep warm function
- Quick heating and long keep warm function
- Removable supply line with continuously adjustable thermostat
- Non-stick coated pan (easy to clean)
- Dimension: 30 x 30 cm, depth: 5 cm
- Heat-resistant glass lid with handle
- Heat-insulated carrying handles

- 220–240 V, 50/60 Hz, 1500 W
- WxHxD approx. 415 x 175 x 300 mm



Scratch resistant ceramic coating

● Art. no. 263 656
EAN 4 006 160 636 567 PU 2



● Art. no. 251 131
EAN 4 006 160 511 314 PU 4





Pizza/party pan
PP 3402

- Pizza/party pan for boiling, frying, steaming, defrosting, keeping warm and making pizzas
- Quick heating and long keep warm function
- Removable supply line with continuously adjustable thermostat
- Non-stick coated pan (easy to clean)
- Ø 36 cm, depth: 3.5 cm
- Heat-resistant glass/metal lid with handle
- Heat-insulated carrying handles

- 220–240 V, 50/60 Hz, 1500 W
- WxHxD approx. 430 x 160 x 360 mm

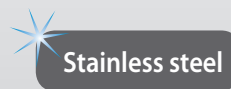

Fondue set
FD 3516

- Stainless steel fondue pot, rustproof (Ø 18.5 cm)
- Filling capacity up to max. 1.2 litre
- Fondue pot with encapsulated sandwich base for better heat distribution – also usable individually on different hobs (gas, electric, glass ceramic, halogen)
- Separate, stable hotplate made of stainless steel
- Continuously adjustable thermostat (illuminated)
- Thermal cut-out
- Thermal fuse
- Stainless steel splash protection with fork holder (removable)
- Accessories: 8 stainless steel fondue forks, color-coded

- 220–240 V, 50/60 Hz, 1200–1400 W
- WxHxD approx. 285 x 180 x 185 mm



Continuously adjustable thermostat (illuminated)



Raclette grill
RG 3517

2 in 1 Raclette grill
RG 3518

- Cool touch housing
- For grilling and browning
- Removable grill plate
- 8 pans
- 8 wooden spatulas
- Continuously adjustable thermostat
- Indicator light
- Non-stick coating on the grill plates and pans (easy to clean)
- Grill area: approx. 40.5 x 30 cm
- Safe base due to rubberized feet

- 220–240 V, 50/60 Hz, 1200–1400 W
- WxHxD ca. 430 x 130 x 340 mm

- Cool touch housing
- For grilling and browning
- Turning iron plate – Combination grill area for grilling fish (smooth surface) or meat (extra deep grooves for an intense grill pattern)
- Natural grill stone for a healthy, low-fat grilling
- Total grill area: ca. 46 x 23 cm (2x ca. 23 x 23 cm)
- 8 pans, 8 wooden spatula
- Continuously adjustable thermostat (blue illuminated)
- Non-stick coating on the grill plates and pans (easy to clean)

- 220–240 V, 50/60 Hz, 1200–1400 W
- WxHxD approx. 465 x 150 x 235 mm



8 wooden spatulas



Natural grill stone for a healthy, low-fat grilling



Continuously adjustable thermostat (illuminated in blue)



Combination grill area for grilling fish or meat (turning iron plate)



● Art. no. 261 705
EAN 4 006 160 617 054 PU 3



● Art. no. 261 706
EAN 4 006 160 617 061 PU 2





2in1

Electric grill lighter EGA 3404

Barbecue standing grill BQS 3508

69

- Electric grill lighter for the safe ignition of grilling charcoal and charcoal briquettes
- No chemicals, no smells
- For clean, fast grilling enjoyment
- Minimum smoke level
- Barbecue fire ignited in about 10 minutes
- Simple operation
- Large ignition surface with 3 filaments
- Incl. depositing aid (wall installation possible)
- Heat-insulated handle (ergonomically designed)
- Easy to clean

- 220–240 V, 50/60 Hz, 800 W
- W x H x D approx. 200 x 75 x 510 mm

- Stand grill in an attractive design with low smoke emission and low smell
- Continuously adjustable thermostat with indicator light
- Chromed grill grid
- Removable grill and heating elements for easy cleaning
- Cool touch housing
- Metal drip tray
- Wind protection (removable)
- Additional tray
- Can be converted to a table grill
- Grill height: approx. 80 cm
- Grilling surface: 35.5 x 24.5 cm

- 230 V, 50 Hz, 2000 W
- W x H x D approx. 510 x 820 x 370 mm



Can be converted to a table grill

● Art. no. 271 676
EAN 4 006 160 716 764 PU 6



● Art. no. 261 697
EAN 4 006 160 616 972 PU 4





Grill rack and warming rack (enameled)



Convenient storage basket for different grilling utensils



Gas grill GG 3590

- 2x heating zones for separate temperature control (2 Burner)
- Sturdy grill hood with integrated temperature display
- Control knobs for continuous temperature setting
- 48,5 x 37,5 cm grill area comprising of one enameled grill rack (dishwasher safe)
- 48,5 cm long warming rack (enameled)
- Removable grease collection tray for easy cleaning
- 2 x burners
- Housing and side trays made of powder-coated steel
- Two wheels for convenient movement
- Convenient storage basket for different grilling utensils
- Large storage room / Storage for gas bottle
- Including gas pressure reduction valve and gas tube for Germany and Austria

Specifications

- Burners: 2
- Main burner: 2x 2,75 kW / 5,5 kW
- Gas consumption: 400 gr/h
- Operating pressure: 50 mbar
- Ignition: Piezo ignition system
- Gas category: 13B/P(50)
- Gas type: Butane, propane, or their mixtures
- Target destinations: D, A, CH
- CE certification: Intertek institute, certification number: 0359BU1034
- W x H x D approx. 970 x 1000 x 550 mm



Integrated temperature display



Art. no. 263 692
EAN 4 006 160 636 925

PU 1

CE 0359



Barbecue table grill BQ 2977 N

- Table grill in an attractive design without fire and smoke
- Cool touch housing
- On/off switch with indicator lamp
- Removable grill and heating elements for easy cleaning
- Metal drip tray
- Grilling surface: 35.5 x 24.5 cm

- 230 V, 50 Hz, 2000 W
- WxHxD approx. 480 x 100 x 360 mm

Barbecue table grill BQ 3507

- Table grill in an attractive design with low smoke emission and low smell
- Continuously adjustable thermostat with indicator light
- Chromed grill grid
- Removable grill and heating elements for easy cleaning
- Cool touch housing
- Metal drip tray
- Wind protection
- Grilling surface: 36 x 25 cm

- 230 V, 50 Hz, 2000 W
- WxHxD approx. 515 x 95 x 375 mm



72

Convection oven HLO 3523

- Gentle cooking by circulating hot air, low-fat and vitamin-preserving
 - Many different uses for baking, roasting, grilling, steaming, braising, defrosting, heating, barbecuing (easy to use)
 - Halogen heating element for faster heating
 - Saves time and energy: requires up to 45 % less energy than a conventional oven
 - Ideal for small kitchens and mobile use
 - Continuously adjustable thermostat from 0–200 °C
 - 12 litre interior
 - Glass bowl: Ø 33 cm
 - Container made of safety glass – heat and scratch-resistant (dishwasher-safe)
 - 60 minute timer with alarm when cooking is completed
 - Indicator lights for operation and temperature
 - Safety switch, practical safety handle
 - Heat-insulated carrying handles
 - Accessories: upper and lower grid, steamer insert, tongs, skewers, lid holder
- 220–240 V, 50/60 Hz, 1200–1400 W
 - WxHxD approx. 380 x 335 x 355 mm

Pizza maker PM 3622

- 1800 Watt
 - Continuously adjustable thermostat
 - Short cooking times
 - Non-stick baking plates
 - Large, heat-insulated handle
 - 2 indicator lights for power supply and heating
 - Temperature “ready” display
 - Large baking surface: approx. Ø 28 cm
 - Cord storage
 - On/Off switch
- 220–240 V, 50/60 Hz, 1800 W
 - WxHxD approx. 315 x 160 x 375 mm



Lower/upper grid



Steamer insert



Art. no. 263 234
EAN 4 006 160 632 347

PU 1



Art. no. 263 720
EAN 4 006 160 637 205

PU 3





Mini oven
MB 3463

Multi pizza oven
MPO 3520

- 8 litre capacity
- Top and bottom heat
- 15 minute timer
- 2 quartz heating elements
- Pull-out grill grid
- Baking tray
- Drawer for crumbs
- Overheating protection

- 220–240 V, 50/60 Hz, 800 W
- W x H x D approx. 365 x 220 x 250 mm

- Pizza oven ideal for grilling and crisping up
- Large grill, ideal for pizza (26 x 25 cm)
- Including baking tray (23.5 x 22 cm)
- Capacity: approx. 12 litre
- Top and bottom heat (combined operation possible)
- 4-step switch (top heat, bottom heat, top and bottom heat combined, off)
- 2 quartz heating elements
- 60 minute timer with end signal
- Stainless steel handle
- Crumb tray
- Overheating protection

- 220–240 V, 50/60 Hz, 1000 W
- W x H x D approx. 375 x 220 x 330 mm



Incl. baking tray (23.5 x 22 cm)

● Art. no. 251 143
EAN 4 006 160 511 437 PU 4



● Art. no. 261 708
EAN 4 006 160 617 085 PU 4





Multi oven
MBG 3521

- 28 litre capacity
- Circulating air
- Top and bottom heat, combined operation
- Revolving spit
- 60 minute timer with end signal
- 5-step switch (top/bottom/top and bottom heat/ revolving spit/off)
- Variable temperature control (100°C–230°C)
- Indicator light
- Includes grill grid, baking tray, revolving spit
- Includes tongs for removing the grill grid and baking tray, tool for removing the revolving spit
- Large viewing window
- 220–240 V, 50/60 Hz, 1500 W
- W x H x D approx. 520 x 335 x 420 mm

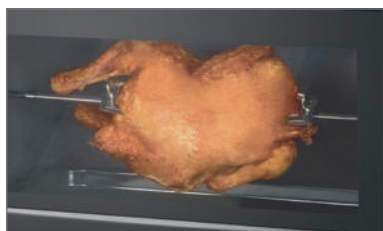

Incl. revolving spit

Multi oven
MBG 3621

- 28 litre capacity
- Circulating air
- Top and bottom heat, combined operation
- Revolving spit
- 60 minute timer with end signal
- 6 level switch
 - Top and bottom heat
 - Top and bottom heat + circulating air
 - Top heat + circulating air
 - Top heat + revolving spit
 - Top and bottom heat + revolving spit + circulating air
 - Off
- Variable temperature control (100°C–230°C)
- Indicator light
- Includes grill grid, baking tray, revolving spit
- Includes tongs for removing the grill grid and baking tray, tool for removing the revolving spit
- Large viewing window
- 220–240 V, 50/60 Hz, 1500 W
- W x H x D approx. 495 x 380 x 330 mm



Incl. revolving spit





Mini kitchen KK 3522

- 2 hotplates
 - 1x Ø 18.5 cm, 1500 watt
 - 1x Ø 15.5 cm, 1000 watt
- 2 different operating controls for the hotplates:
 - Small – rotary switch level 0–4
 - Large – rotary switch level 0, 850, 1100 and 1500 watt
- 28 litre capacity
- Combined operation (baking and cooking at the same time)
- Top and bottom heat (900/600 watt)
- Possible baking/grilling alternatives:
 - Top and bottom heat
 - Only bottom heat
 - Top heat
- Infinitely adjustable thermostat
- Indicator light
- Oven door with viewing window
- Including grill grating, baking sheet, and crumbs drawer, as well as hookable handle for pulling out the sheet/grating
- Power supply:
 - 600 watt oven (bottom heat), 900 watt oven (top heat)
 - 1000 watt hotplate (small), 1500 watt hotplate (large)
 - 3400 watt (total power consumption)
- 220–240 V, 50 Hz, 3400 W
- WxHxD approx. 518 x 415 x 360 mm

● Art. no. 261 709
EAN 4 006 160 617 092 PU 1



Microwave MW 785

- 700 watt microwave
- 20 litre oven capacity
- 5 level
- Rotating plate, Ø approx. 24.5 cm
- 30 minute timer with end signal
- Oven light
- Large viewing window
- 230 V, 50 Hz, 1200 W
- WxHxD approx. 455 x 265 x 340 mm

-
- Art. no. 253 139
EAN 4 006 160 531 398 PU 1
 - Art. no. 263 717
EAN 4 006 160 637 175 PU 1
 - Art. no. 253 140
EAN 4 006 160 531 404 PU 1

2in1 Microwave with grill MWG 786

Features such as 785 MW + Grill

- 900 watt grill
- 5 microwave power level
- 3 level in combined operation grill/microwave
- 1 grill level
- Cooking grid: Ø approx. 21.0 cm
- 230 V, 50 Hz, 1200 W
- WxHxD approx. 455 x 265 x 340 mm

-
- Art. no. 253 141
EAN 4 006 160 531 411 PU 1
 - Art. no. 253 145
EAN 4 006 160 531 459 PU 1
 - Art. no. 253 146
EAN 4 006 160 531 466 PU 1





2in1



ELECTRONIC

3in1

Convection

Microwave with grill MWG 787

- 700 watt microwave
- 900 watt grill
- 20 litre capacity
- 6 microwave power level
- 2 level in combined operation grill/microwave
- 1 grill level
- 9 automatic programs incl. defrost program
- Express program
- Rotating plate: Ø approx. 24.5 cm
- Cooking grill: Ø approx. 21.0 cm
- 60 minute timer with end signal
- Easy Tronic
- Digital clock
- Child lock
- Oven light
- Large viewing window
- 230 V, 50 Hz, 1200 W
- W x H x D approx. 455 x 265 x 335 mm

Microwave with grill and convection MWG 788 H

- Stainless steel front
- 800 watt microwave power
- 1350 watt grill
- 1350 watt convection
- Quick-start function
- 20 litre capacity
- 11 microwave power level
- 2 level in combined operation (grill/microwave)
- 4 level in combined operation (convection/microwave)
- 1 grill level
- 10 temperature settings for convection
- 9 automatic programs incl. defrost program
- Rotating plate, Ø approx. 24.5 cm
- Grilling grid, Ø approx. 21.0 cm
- 95 minute timer with end signal
- Quartz heating elements
- Digital clock
- Child lock
- Oven light
- 230 V, 50 Hz, 1350 W
- W x H x D approx. 455 x 262 x 375 mm





4in1

Convection

Pizza function

Microwave with grill and convection MWG 789 H

- 800 watt microwave power
- 1200 watt grill
- 1200 watt convection
- 23 litre capacity
- 5 microwave power level
- 4 level in combined operation (grill/microwave)
- 1 grill level
- 10 temperature settings for convection
- 10 automatic programs
- Defrost program
- Quick-start program
- Incl. pizza program and pizza plate, Ø approx. 28.0 cm
- Rotating plate, Ø approx. 27.0 cm
- Grilling grid, Ø approx. 21.0 cm
- 95 minute timer with end signal
- Quartz heating elements
- Digital clock
- Child lock
- Oven light

- 230 V, 50 Hz, 1300 W
- W x H x D approx. 490 x 295 x 410 mm

3in1

Convection

Stainless steel

Microwave with grill and convection MWG 775 H

- Stainless steel housing
- Reflecting glass front
- 800 watt microwave
- 1200 watt grill
- 1200 watt convection
- 23 litre capacity
- 4 microwave power level
- 3 level in combined operation (microwave/grill)
- 10 level in combined operation (microwave/convection)
- 1 grill level
- 10 temperature settings for convection
- 9 automatic programs
- Defrost program
- Rotating plate, Ø approx. 27.0 cm
- Grilling grid, Ø approx. 22.0 cm
- 95 minute timer with end signal
- Quartz heating elements
- Digital clock
- Child lock
- Oven light

- 230 V, 50 Hz, 1300 W
- W x H x D approx. 485 x 295 x 405 mm



Pizza function incl. pizza plate

Pizza plate with active, heat-storing special coating for extra crispy and crunchy pizza crusts.

The pizza plate is preheated via the microwave function and then baking of the pizza is completed in combination operation.

Ideal for deep-frozen pizza and freshly prepared pizza crusts.

Art. no. 253 147
EAN 4 006 160 531 473

PU 1



Art. no. 253 126
EAN 4 006 160 531 268

PU 1



PREIS-/LEISTUNGSSIEGER	
ETM TESTMAGAZIN - URTEIL	
Clatronic MWG 779H	
GUT	87,0 %
Im Test: 11 Kombi-Mikrowellen Testurteile: 2x sehr gut, 8x gut, 1x befriedigend www.etm-testmagazin.de	Heft 04/2016

4in1
Convection
Stainless steel
**Stand-alone/
Under-cabinet mounting**
**Double-grill microwave
MWG 779 H**

- Stainless steel housing
 - Stainless steel interior
 - Double grill for, for example, crispy pizza, baguettes, soufflés, etc. (1200 watt top heat, 500 watt lower heat)
 - 900 watt microwave
 - 1700 watt double grill
 - 2300 watt convection
 - Quartz top heating element
 - 25 litre capacity
 - 5 microwave power level
 - 10 temperature settings convection
 - 10 automatic programs
 - Defrost program
 - Quick-start program
 - Incl. pizza program and pizza stone, Ø approx. 30.0 cm
 - Incl. enameled rotating plate, dishwasher-safe and scratchproof, Ø approx. 31.5 cm
 - Grilling grid, Ø approx. 25.0 cm
 - 95 minute timer with end signal
 - Start delay
 - Digital clock
 - Child lock
 - Oven light
- 230 V, 50 Hz, 1450 W
 - W x H x D approx. 510 x 300 x 430 mm

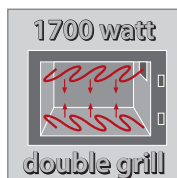

Pizza function incl. pizza stone

**Combined microwave oven with grill
MWG 777 U**

- 800 watt microwave
 - 1000 watt grill
 - 20 litre capacity
 - 5 microwave power level
 - 3 level in combined operation
 - 1 grill level
 - Rotating plate, Ø approx. 24.5 cm
 - Grilling grid, Ø approx. 21.0 cm
 - 30 minute timer with end signal
 - Oven light
 - Large viewing window
 - Can be positioned as required or used as a built-under appliance (Incl. installation material)
- 230 V, 50 Hz, 1250 W
 - W x H x D approx. 461 x 365 x 280 mm



Built-under appliance

 Art. no. 253 131
 EAN 4 006 160 531 312

PU 1

 Art. no. 253 129
 EAN 4 006 160 531 299

PU 1





Stand-alone/
Under-cabinet mounting

Combined microwave oven with grill
MWG 778 U

- Stainless steel front
- 800 watt microwave
- 1000 watt grill
- 20 litre capacity
- 5 microwave power level
- 2 level in combined operation
- 1 grill level
- 8 automatic programs
- Defrost programs, selectable according to time and weight
- Quick-start program
- Rotating plate, Ø approx. 24.5 cm
- Grilling grid, Ø approx. 21.0 cm
- 95 minute timer with end signal
- Easy Tronic, digital clock, child lock
- Oven light
- Large viewing window
- Can be positioned as required or used as a built-under appliance (incl. installation material)
- 230 V, 50 Hz, 1250 W
- W x H x D approx. 460 x 285 x 370 mm



Built-under appliance



Built-in microwave with grill
MWG 2215 EB

- Built-in microwave with frame
- Stainless steel front, stainless steel interior
- 800 watt microwave
- 1000 watt grill
- 5 microwave power level
- 2 level in combined operation (grill/microwave)
- 1 grill level
- 8 automatic programs
- Defrost programs, selectable according to time and weight
- 20 litre capacity
- Rotating plate, Ø approx. 24.5 cm, grilling grid, Ø approx. 21 cm
- 95 minute timer with end signal
- Start delay
- Child lock
- Oven light

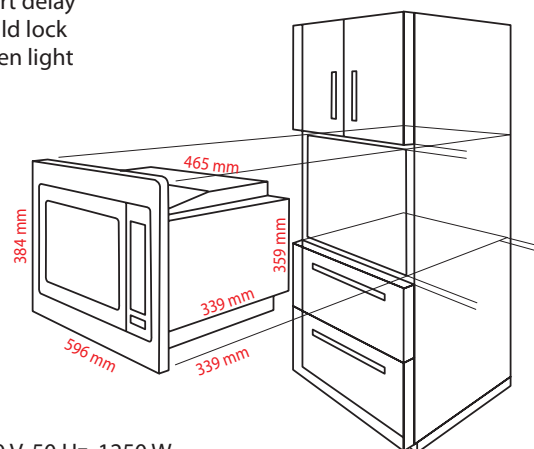

- 230 V, 50 Hz, 1250 W
- Appliance (W x H x D): 465 x 359 x 339 mm
- Appliance with frame (W x H x D): 596 x 384 x 339 mm
- Weight: approx. 14 kg





Built-in microwave with grill and convection
MWG 2216 H EB

Built-in microwave with grill and convection
MWG 2265 H EB

80

- Built-in microwave with frame
- Stainless steel front, stainless steel interior
- 900 watt microwave
- 1100 watt grill
- 2500 watt convection function
- 5 microwave power level
- 2 level in combined operation (grill/microwave)
- 2 level in combined operation (convection/microwave)
- 1 grill level
- 10 temperature settings for convection (130°C–220°C)
- 10 automatic programs
- Defrost program, quick-start program
- 25 litre capacity
- Rotating plate, Ø approx. 31,5 cm, grilling grid, Ø approx. 27,5 cm
- 95 minute timer with end signal
- Start delay
- Child lock
- Oven light

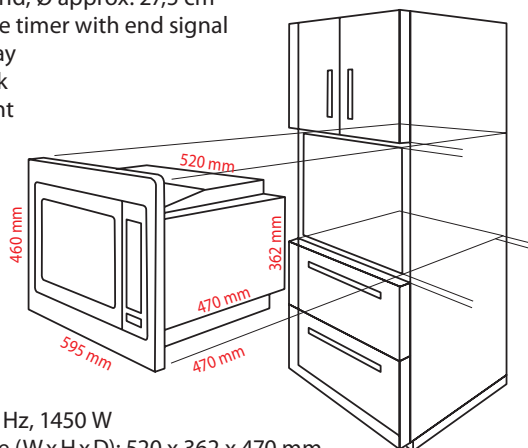

- 230 V, 50 Hz, 1450 W
- Appliance (W x H x D): 520 x 362 x 470 mm
- Appliance with frame (W x H x D): 595 x 460 x 470 mm
- Weight: approx. 21 kg

- Built-in microwave oven in frameless design
- Stainless steel front/interior
- Multi-function display (black/white)
- Control knob (illuminated)
- 900 watt microwave
- 1100 watt grill
- 2500 watt convection
- 5 microwave power level
- 4 level in combined operation (microwave/grill/convection)
- 1 grill level
- 10 temperature settings for convection (130°C–220°C)
- 10 automatic programs
- Defrost program, quick-start program
- 25 litre capacity
- Rotating plate, Ø approx. 31,5 cm, grilling grid, Ø approx. 27,5 cm
- 95 minute timer with end signal
- Child lock
- Oven light

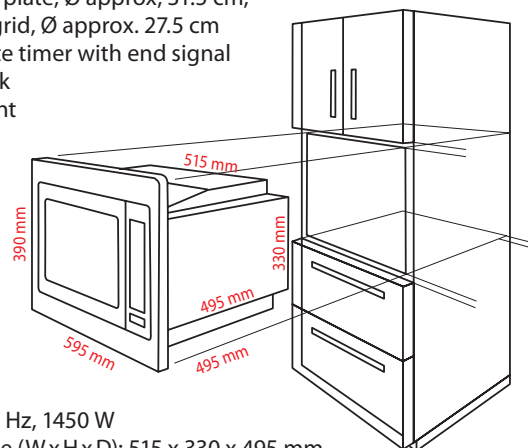

- 230 V, 50 Hz, 1450 W
- Appliance (W x H x D): 515 x 330 x 495 mm
- Appliance with frame (W x H x D): 595 x 390 x 495 mm
- Weight: approx. 21 kg

● Art. no. 622 161
EAN 4 004 470 221 619 PU 1



● Art. no. 622 651
EAN 4 004 470 226 515 PU 1





Alcohol tester
AT 3605

Preserving boiler
EKA 3338

- Alcohol tester in an attractive design
- Measurement standby function
- 2 digital LCD displays
 - Display in parts per thousand and g/l from 0.0 to 1.9 ‰ (red illuminated)
 - Temperature display in °C and °F
 - Time display (12/24 h)
- Optical warning at 0,2 ‰ and 0,5 ‰
- Countdown function (measuring readiness)
- Alarm function
- Automatic switch-off, prolongs battery life
- Low weight
- Battery operation: 2x AAA (batteries not included)

- 1800 watt
- 25 litre tank capacity for up to 14 jars
- Enameled housing, scratch-resistant
- Closed pot bottom, concealed stainless steel heating element
- Variable temperatur control (30–100 °C)
- Indicator light
- Integrated drain tap for practical filling of mulled wine, punch or other hot drinks, for example
- Hard-wearing enamel, tasteless
- Grid insert
- Plastic handles, heat-insulated
- Overheating protection

- 230 V, 50 Hz, 1800 W
- W x H x D approx. 455 x 495 x 435 mm



2 digital LCD displays for:
 – Time, temperature
 – Alcohol content (red illuminated)

Art. no. 271 704
 EAN 4 006 160 717 044 PU 12

Art. no. 263 135
 EAN 4 006 160 631 357 VE 1





Single hotplate
EKP 3582

- Hotplate, Ø approx. 180 mm, 1500 watt
- Infinitely adjustable thermostat
- Indicator light
- Heat-resistant finish
- High stability

- 230 V, 50 Hz, 1500 W
- WxHxD approx. 360 x 70 x 285 mm

Double hotplate
DKP 3583

- 2 hotplates
 - 1 x Ø approx. 180 mm, 1500 watt
 - 1 x Ø approx. 150 mm, 1000 watt
- 2 continuously variable thermostats
- 2 indicator lights
- Heat-resistant finish
- High stability

- 230 V, 50 Hz, 2500 W
- WxHxD approx. 570 x 70 x 285 mm



Single induction hotplate EKI 3569

- Induction hotplate with high-quality, eco- friendly glass-ceramic-surface
 - Heating only takes seconds thanks to induction technology
 - Scratch-resistant smooth cooking area (very easy to clean)
 - ECO-Save – 55% time savings compared to conventional cooking plates, no preheating phase, energy saving
 - Automatic pot detection – automatic switch-off in the case of non-induction pots
 - 10 power level and 10 temperature level with LED indication (60 °C–240 °C)
 - Electronic sensor touch control panel with display for comfortable operation
 - 3 LED indicator lights
 - 180 minute timer with automatic switch-off and end signal
 - Countdown indication
 - Automatic switch-off after 120 min. without operation
 - Automatic switch-off after removal of the pot
 - Child lock
 - High stability due to non-slip feet
- 220–240 V, 50/60 Hz, 2000 W
 - W x H x D approx. 290 x 65 x 370 mm

Double induction hotplate DKI 3609

- Induction double hotplate with high-quality, eco-friendly glass-ceramic-surface
 - Heating only takes seconds thanks to induction technology
 - Scratch-resistant smooth cooking area (very easy to clean)
 - ECO-Save – 55% time savings compared to conventional cooking plates, no preheating phase, energy saving
 - Automatic pot detection – automatic switch-off in the case of non-induction pots
 - LED display
 - Each hob with 16 function level – 6 power level and 10 temperature level (60 °C–240 °C)
 - Electronic Sensor Touch control panel with display for comfortable operation
 - 2x 3 LED indicator lights
 - 180 minute timer with automatic switch-off and end signal
 - Countdown indication on the LED display
 - Automatic switch-off after 120 min. without operation
 - Automatic switch-off after removal of the pot
 - High stability due to non-slip feet
- 220–240 V, 50/60 Hz, 3500 W max.
 - W x H x D approx. 600 x 75 x 355 mm

2in1

84

**Travelling steam iron/
steam brush DB 3108 B**

- Variable temperature control, suitable for all types of fabric
- Open turning handle
- Indicator light
- Non-stick-coated sole plate
- Combined attachment: fluff removal and brushes
- Vertical steam function for smoothing hanging textiles
- Transparent water container (approx. 30 ml)
- 230 V, 50 Hz, 800 W
- WxHxD approx. 185 x 226 x 128 mm

**Steam iron
DB 3578**

- Special stainless steel sole plate
- Steam jet function, spray device and vertical steam
- Variable temperature control
- Continuous steam regulation
- Dry function (steam can be switched off)
- Practical self-cleaning function
- Transparent water container (approx. 135 ml)
- Cable attached via 360° turnable joint
- Indicator light
- 220–240 V, 50/60 Hz, 1700 W
- WxHxD approx. 110 x 140 x 260 mm

**Steam iron
DB 3105**

- Special stainless steel sole plate
- Steam jet function, spray device and vertical steam
- Variable temperature control
- 3-level steam control
- Dry function (steam can be switched off)
- Practical self-cleaning function
- Transparent water container (approx. 130 ml)
- Cable attached via 360° turnable joint
- Indicator light
- 230 V, 50 Hz, 2000 W
- WxHxD approx. 115 x 155 x 275 mm



Art. no. 263 531
EAN 4 006 160 635 317 PU 12



Art. no. 263 659
EAN 4 006 160 636 598 PU 6



Art. no. 263 528
EAN 4 006 160 635 287 PU 6





Steam iron DB 3475

- Special stainless steel sole plate
- Steam jet function, spray device and vertical steam
- Variable temperature control
- Continuous steam regulation
- Dry function (steam can be switched off)
- Practical self-cleaning function
- Transparent water container (approx. 200 ml)
- Cable attached via 360° turnable joint
- Indicator light

- 220–240 V, 50/60 Hz, 2200 W
- WxHxD approx. 110 x 150 x 275 mm

Steam iron DB 3512

- Special stainless steel sole plate
- 7 functions:
 - Spray device
 - Steam jet function
 - Vertical steam
 - Dry function (steam can be switched off)
 - Self-cleaning function (switchable)
 - Anti-drip function
 - Anti-calc system
- Variable temperature control
- Continuous steam regulation
- Transparent water container (approx. 360 ml)
- Cable attached via 360° turnable joint
- Indicator light

- 220–240 V, 50/60 Hz, 2500 W
- WxHxD approx. 115 x 150 x 290 mm



Ceramic

Steam iron
DB 3485

- Scratch-resistant ceramic sole plate with outstanding sliding behaviour
 - 5 functions:
 - Spray device
 - Steam jet function
 - Vertical steam
 - Dry function (steam can be switched off)
 - Self-cleaning function (switchable)
 - Variable temperature control
 - Continuous steam regulation
 - Transparent water container (approx. 250 ml)
 - Cable attached via 360° turnable joint
 - Indicator light
 - Measuring cup
- 220–240 V, 50/60 Hz, 1800–2200 W
- WxHxD approx. 118 x 134 x 280mm



Ceramic

Steam iron
DB 3329

- Scratch-resistant ceramic sole plate with outstanding sliding behaviour
 - Steam jet function, spray device and vertical steam
 - Variable temperature control
 - Continuous steam regulation
 - Dry function (steam can be switched off)
 - Anti-calc filter system
 - Anti-drip function
 - Self-cleaning function (switchable)
 - Transparent water container (approx. 320 ml)
 - Rubberized handle for non-slip handling
 - Rubberized rest for excellent stability
 - Cable attached via 360° turnable joint
 - Indicator light
- 220–240 V, 50/60 Hz, 2500 W
- WxHxD approx. 125 x 155 x 310 mm



Easy-running, scratch-resistant ceramic sole plate

Art. no. 261 668
EAN 4 006 160 616 682 PU 6



Art. no. 263 132
EAN 4 006 160 631 326 PU 6





Ceramic

Steam iron
DB 3486

- Scratch-resistant ceramic sole plate with outstanding sliding behaviour
- 7 functions:
 - Spray device
 - Steam jet function
 - Vertical steam
 - Dry function (steam can be switched off)
 - Self-cleaning function (switchable)
 - Anti-drip function
 - Anti-calc filter system
- Variable temperature control
- 4-level steam control (0-1-2-3)
- Transparent water container (approx. 360 ml)
- Rubberized handle for non-slip handling
- Rubberized rest for excellent stability
- Cable attached via 360° turnable joint
- Indicator light

- 220–240 V, 50/60 Hz, 2400–2800 W
- WxHxD approx. 120 x 160 x 300 mm



Easy-running, scratch-resistant ceramic sole plate



2in1

Also cordless useable

Ceramic

Steam iron
DBC 3388

- Scratch-resistant ceramic sole plate with outstanding sliding behaviour
- Steam iron, cordless
- 10 different functions: used without a cord, dry ironing (steam can be switched off), steam ironing, steam jet, vertical steam, 3-level steam setting, spray function, anti-calc filter system, anti-drip function, practical self-cleaning function
- Variable temperature control
- Transparent water container (approx. 220 ml)
- Incl. table attachment for stability and one-handed operation
- Rubberized handle for non-slip handling
- Indicator light

- 220–240 V, 50 Hz, 2000 W
- WxHxD approx. 290 x 245 x 130 mm



Easy-running, scratch-resistant ceramic sole plate



Incl.
2 anti-scale
cartridges

Incl.
2 anti-scale
cartridges

Ceramic



ELECTRONIC

Ceramic

88

Steam ironing unit
DBS 3611

NEW! Steam ironing unit
DBS 3634

- Scratch-resistant ceramic sole plate with outstanding sliding behaviour
 - Constantly high heat resistance and optimal steam generation
 - Even and consistent heat distribution through 20 steam nozzles
 - With steam jet function (horizontal and vertical)
 - Constant high steam output: max. 80 g/min.
 - Removable water tank (2.3 litre capacity), in case of average operation sufficient for approx. 90 minutes
 - Permanent refill function – refilling of the water tank during the operation possible
 - Continuously adjustable temperature control
 - 2 anti-scale cartridges
 - Extra large rest plate to provide the iron with a stable rest
 - Arrestable holding device
 - Long connection cable
 - Cable take-up on the base
- 220–240 V, 50/60 Hz, 2000–2400 W
 ■ WxHxD approx. 205 x 315 x 365 mm

- Scratch-resistant ceramic sole plate with outstanding sliding behaviour
 - Electronic
 - Control LCD display (blue illuminated) for indication of: steam, change indicator (anti-scale cartridge), service interval
 - Constantly high heat resistance and optimal steam generation
 - Even and consistent heat distribution through 20 spray nozzles
 - With steam jet function (horizontal and vertical)
 - Constant high steam output: max. 80 g/min.
 - Removable water tank (2.3 litre capacity), in case of average operation sufficient for approx. 90 minutes
 - Permanent refill function – refilling of the water tank during the operation possible
 - Continuously adjustable temperature control
 - Incl. 2 anti-scale cartridges
 - Extra large rest plate to provide the iron with a stable rest
 - Arrestable holding device
 - Long connection cable
 - Cable take-up on the base
- 220–240 V, 50/60 Hz, 2000–2400 W
 ■ WxHxD approx. 205 x 315 x 365 mm



Scratch resistant and smooth running ceramic sole plate



Removable water tank (2.3 litre capacity)



Replacement cartridge for DBS 3611 and DBS 3634

Art. no. 8 936 110
EAN 4 006 160 632 606



Scratch resistant and smooth running ceramic sole plate



Removable water tank (2.3 litre capacity)



Control LCD display (blue illuminated)

● Art. no. 263 708
EAN 4 006 160 637 083 PU 2
● Art. no. 263 707
EAN 4 006 160 637 076 PU 2



● Art. no. 263 751
EAN 4 006 160 637 519 PU 2





Mini-washing machine
MWA 3540

- Light mini-washing machine
- Obviates the need for tedious hand washing at home and when travelling
- Ideal for both small washes and for sensitive laundry items
- Washes quickly and effectively with a consistent result
- Low water, electricity and detergent consumption
- Ideally suited for camping, holidays and single households
- 15 minute timer
- Incl. drainage hose and water inlet
- Capacity: 13 litre max. / 1.5 kg

- 230 V, 50 Hz, 135 W
- W x H x D approx. 330 x 460 x 360 mm



15 minute timer



Incl. water inlet and drainage hose



Water level indicator

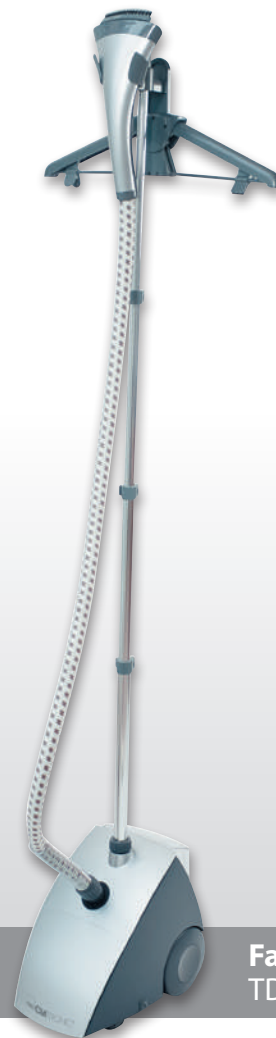

Fabric steamer
TDC 3432



Detachable 1.2 litre capacity water tank



Vertical steam ironing for hanging clothes



Gentle and effective method for removing creases from fabrics

- Steamer for steam ironing, removes wrinkles and lint
- Gentle and effective method for removing creases from fabrics
- The gentle steam effect extends the lifespan of your clothes
- Saves time over traditional ironing
- Also suitable for sensitive materials
- Vertical steam function
- Quick warm-up time through 1500 watt of power – ready to use in around 50 seconds
- Detachable 1.2 litre capacity water tank
- Use for up to 40 mins on a full tank
- Steplessly height-adjustable telescopic pole (to 1.35 m) for individual adjustment to body height and for easy storage
- Constant steam output: around 30 g/min.
- Vertical steam ironing for hanging clothes, curtains etc.
- Anti-drip system
- Easy to transport – through 2 large rollers and 2 360° casters
- Accessories: Trousers and clothes hanger, brush head, fabric brush attachment for removing wrinkles and bobbles
- On/off switch (illuminated)
- Overheating protection
- Fire protection fuse
- Cable length approx. 1.80 m

- 230 V, 50 Hz, 1500 W
- BxHxD ca. 340 x 1640 x 230 mm



NEW! Steam cleaner
DR 3653

Steam cleaner
DR 3535

- Steam cleaner, cleans, disinfects and degreases without limescale residues and cleaning strip
- 3.5 bar max. steam pressure
- Approx. 250 ml water tank
- Extra-long cable (approx. 5.0 m)
- Overpressure protection
- Overheating protection
- Incl. 9 accessories: brush, angle, fleece, window cleaner and universal cleaning attachment, 360° swiveling steam nozzle, hose, measuring cup, funnel
- 220–240 V, 50/60 Hz, 900–1050 W
- WxHxD approx. 250 x 225 x 135 mm

- Steam cleaner, cleans, disinfects and degreases without limescale residues and cleaning strip
- 3.5 bar max. steam pressure
- Approx. 300 ml water tank
- Extra-long cable (approx. 5 m)
- Overpressure protection
- Overheating protection
- Includes 9 accessories: 2x brush, nozzle, angle, fleece and windowcleaning attachments, hose, measuring beaker
- 220–240 V, 50/60 Hz, 1000 W
- WxHxD approx. 210 x 320 x 160 mm



Round brush attachment



Incl. 360° swiveling steam nozzle



Universal cleaning attachment



2x round brush attachment

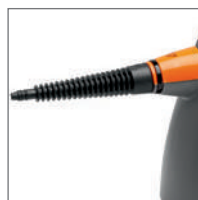

Jet nozzle attachment

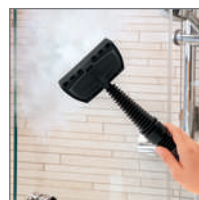

Universal cleaning attachment



Angle attachment



Fleece



Measuring cup



Angle attachment



Fleece



Measuring cup

● Art. no. 263 785
EAN 4 006 160 637 854 PU 6



● Art. no. 283 033
EAN 4 006 160 830 330 PU 2





Steam cleaner
DR 3536

Steam cleaner
DR 3280

- Steam cleaner, cleans, disinfects and degreases without limescale residues and cleaning strip
- 3.5 bar max. steam pressure
- Approx. 600 ml water tank
- Aluminum boiler
- Indicator light (mains and standby)
- Safety tank lid with pressure relief valve
- Overheating protection
- On/off switch protected against water spray
- Practical carrying handle
- Smooth-running wheels
- Steam control on the handle
- Incl. 9 accessories: 2-part extendable insertable tube, floor brush, non-woven cloth, window wiper, jet nozzle attachments, round brush attachment, funnel, measuring beaker
- 230 V, 50/60 Hz, 1350 W
- W x H x D approx. 670 x 260 x 285 mm

- Steam cleaner, cleans, disinfects and degreases without limescale residues and cleaning strip
- 4 bar steam pressure
- Approx. 1.5 litre water tank
- Stainless steel boiler
- Indicator lights (mains and standby)
- Safety tank lid with pressure relief valve
- Overheating protection
- On/off switch protected against water spray
- Practical open carrying handle
- Smooth-running wheels
- Steam control on the handle
- Additional locking button for continuous operation
- Incl. 10 accessories: 2-part extendable insertable tube, floor brush with cloth holder, non-woven cloth, window wiper, 2 jet nozzle attachments, 2 round brush attachments of different sizes, funnel, measuring beaker
- Integrated accessory compartment
- 220–240 V, 50/60 Hz, 1500 W
- W x H x D approx. 670 x 260 x 285 mm

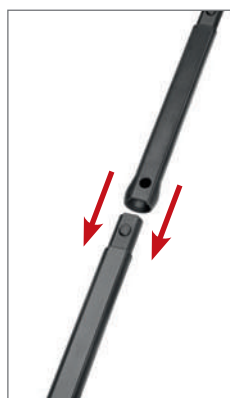

Floor brush



Round brush attachment



Window wiper



Angle attachment



Art. no. 283 034
EAN 4 006 160 830 347

PU 1



Art. no. 283 013
EAN 4 006 160 830 132

PU 1





Incl. spraying bottle



High-pressure cleaner HDR 3597

- Mobile high-pressure cleaner with 2 large wheels for use in areas of gentle care like cars, motorcycles, bicycles, and also for powerful cleaning, such as sidewalks, garden furniture/ tools, etc.
 - Approx. 90 bar
 - Delivery volume: 300 l max./h (5 l max./min.)
 - Area capacity: approx. 20 m²/h
 - Inlet temperature: 40 °C max.
 - 1400 W max.
 - Integrated water filter for protection of the pump against entry of dirt
 - Large work reach by 5 m long connection cable and 5 m long high-pressure hose
 - Compact housing with low weight (5.7 kg)
 - Quick, clean and easy use of detergents with the practical detergent bottle (300 ml)
 - Adjustable high-pressure nozzle
 - High-pressure gun
 - On/off switch (splashproof)
 - Practical cable and hose winding on the unit for clean and space-saving storage
 - Additional accessories can be stored on the unit
 - Incl. carrying handle
- 230 V, 50 Hz, 1400 W
 - W x H x D approx. 255 x 480 x 245 mm



Incl. cleaning agent bottle (300 ml)



Incl. practical cable reel



Mobile use – gentle and powerful cleaning

Window cleaner WC 3528

- Rechargeable battery-operated window cleaner set for daily use
 - Streak-free, time-saving, and hygienic cleaning for example of flat surfaces, windows, glass doors, mirrors, shower stalls, car windows etc.
 - 2-in-1 cleaning/suction function
 - drip-free cleaning by 270 mm wide suction nozzle
 - thorough cleaning by 310 mm wide micro fleece attachment
 - High-power ni-mh battery for up to 40 min. cleaning time
 - Included spraying bottle and micro fleece attachment (machine-washable)
 - Easy handling because of low weight (600 g)
- Charging power supply: 230–240 V, 50/60 Hz
 - Battery: 3.6 V, 1500 mAh
 - W x H x D approx. 270 x 110 x 360 mm



Micro fleece cloth pad for cleaning (310 mm, removable)

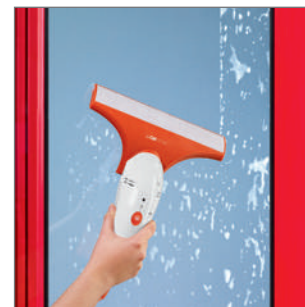

Width suction nozzle for cleaning free of streak (270 mm)

Art. no. 282 927
EAN 4 006 160 829 273

PU 1



Art. no. 263 605
EAN 4 006 160 636 055

PU 4





Fleece attachment for thorough cleaning



Window-cleaning attachment, cleans without streaks and limescale residue



Accessories: 2x microfiber cloth, measuring beaker, window cleaner, nozzle, brush, carpet glider attachment

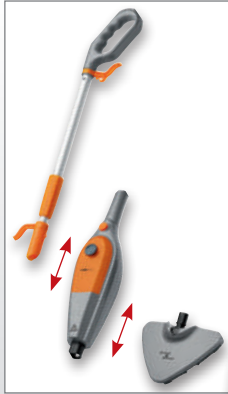

Space-saving storage by easy separation of the components



Accessories: Carpet glider attachment, 2x microfiber cloth



Steam mop DR 3539



- Steam cleaner cleans, disinfects and removes grease at 100°C without grease marks and residues
 - Suitable for different surfaces: e.g. laminates, wooden floors, marble, rubber, slate, ceramics
 - Cleans fabric surfaces such as carpets, mats and cushions
 - Environmentally friendly and hygienic cleaning without the use of chemicals
 - Kills bacteria through high steam power
 - Maximum disinfection and intensive cleaning
 - Ready to use in around 30 seconds
 - Approx. 300 ml water tank
 - Use for up to 30 min. on a full tank
 - Up to 25 g steam/min.
 - Carpet glider attachment
 - Aluminium telescopic tube
 - Removable handle and nozzle for easy use by hand
 - Accessories: 2x microfiber cloth, measuring beaker, window cleaner, nozzle, brush
 - Long lead, approx. 5.0 m
 - Electric lead take-up
 - Fire protection fuse
- 220–240 V, 50/60 Hz, 1500 W
■ W x H x D approx. 260 x 1200 x 210 mm

Art. no. 263 621
EAN 4 006 160 636 215

PU 3



Steam mop DR 3431

- Steam cleaner cleans, disinfects and removes grease at 100°C without grease marks and residues
 - Suitable for different surfaces: e.g. laminates, wooden floors, marble, rubber, slate, ceramics
 - Cleans fabric surfaces such as carpets, mats and cushions
 - Environmentally friendly and hygienic cleaning without the use of chemicals
 - Kills bacteria through high steam power
 - Maximum disinfection and intensive cleaning
 - Ready to use in around 30 seconds
 - Approx. 500 ml water tank, detachable
 - Use for up to 40 mins on a full tank
 - Up to 35 g steam/min.
 - Continuously adjustable steam quantity
 - Space-saving storage with folding handle
 - Accessories: 2 x microfiber cloth, carpet glider attachment, mMeasuring beaker
 - Long lead, approx. 5.0 m
 - Electric lead take-up
 - Fire protection fuse
- 220–240 V, 50 Hz, 1500 W
■ W x H x D approx. 315 x 1120 x 190 mm



Space-saving folding handle and detachable water tank

Art. no. 263 560
EAN 4 006 160 635 607

PU 3





**Battery vacuum cleaner
AKS 827**

- With 3 rechargeable Ni-Mh batteries
- Nozzle for small gaps, brush nozzle
- Permanent dust filter, washable
- Charge indicator light (LED)
- Charger mains adapter
- Foot/wall mounting (installation materials not supplied)

- Charger mains adapter: 230 V, 50 Hz
- Rechargeable battery: 3.6 V, 1400 mAh
- WxHxD approx. 100 x 130 x 310 mm

**Battery wet/dry vacuum
cleaner AKS 828**

- Wet/dry vacuum cleaner
- Powerful battery vacuum cleaner with three rechargeable batteries
- Permanent dust filter, washable
- Charge indicator light (LED)
- Charger mains adapter
- Accessories: Recess nozzle, attachment for wet vacuuming, wall mounting

- Charger mains adapter: 230 V, 50 Hz
- Rechargeable battery: 3.6 V, 1400 mAh
- WxHxD approx. 110 x 130 x 380 mm



● **Art. no. 281 044**
EAN 4 006 160 810 448 PU 6



● **Art. no. 281 052**
EAN 4 006 160 810 523 PU 6





Battery vacuum cleaner AKS 832

- Wet/dry vacuum cleaner
- Powerful battery vacuum cleaner with 10 rechargeable batteries
- Permanent dust filter (washable)
- Charge control lamp (LED)
- 12 V and battery operation possible
- Direct-Drive function: with fully discharged battery, the vacuum cleaner can be used immediately in 12 V operation
- Cable storage compartment
- Accessories: 2x crevice nozzle (1x 13 cm, 1x 26 cm), attachment for wet vacuuming, brush nozzle, 12 V adapter cable
- Charger mains adapter: 230 V, 50 Hz
- Rechargeable battery: 12 V / Battery (NiMh), 1400 mAh
- WxHxD approx. 125 x 130 x 400 mm



Hand vacuum cleaner HS 2631

- Hand vacuum cleaner for vacuuming of: furniture, upholstery, frames, curtains, books, computers, cars, and much more
- Compact size: 24 x 12 x 15 cm
- Permanent dust filter
- Easy to clean
- Large operation range (6 m cable)
- Low weight
- Vertical storage (space saving)
- Accessories: flexible „vacuum snout“ with crevice nozzle, small and large brush, shoulder strap
- 230 V, 50 Hz, 700 W max.
- WxHxD approx. 110 x 185 x 360 mm



Attachment for wet vacuuming



360° brush nozzle



Extra-long crevice nozzles, for example, for use in the car

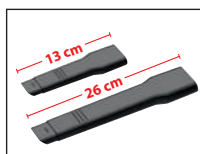

● Art. no. 281 055
EAN 4 006 160 810 554 PU 4



● Art. no. 282 197
EAN 4 006 160 821 970 PU 6





Incl. battery vacuum cleaner



Charging station suitable for wall mounting



Space-saving folding handle



2in1

NEW! Floor vacuum cleaner
BS 1305 A



Incl. brush tool



Incl. crevice tool



Also suitable as hand vacuum cleaner



2in1



NEW! Floor vacuum cleaner
BS 1306



- Accu-hand and floor vacuum cleaner, for flexible and individual operations as brush-/hand vacuum cleaner
- Permanent dust filter (washable)
- Powerful 12 V, 1800 mAh Accus
- LED charge level indicator (illuminated)
- 12 V and battery operation possible
- Cable free (for flexible use)
- 180° rotatable double joint for optimal mobility
- Bagless filter technology
- Incl. telescopic crevice nozzle and electrical, rotating turbo floor brush
- Charging station suitable for wall mounting (incl. mounting material)
- Space-saving folding handle
- Charger mains adapter: 230–240 V, 50 Hz
- Rechargeable battery: 12 V, 1800 mAh
- W x H x D approx. 110 x 1112 x 270 mm (extended)



180° rotatable double joint for optimal mobility



Electrical, rotating turbo floor brush

- 2 in 1 – Floor and hand vacuum cleaner
- Eco-Cyclon
- Also suitable as hand vacuum cleaner for vacuuming of: furniture, upholstery, frames, curtains, books, computers, cars and much more
- Multi filter system
- HEPA-Filter
- Two part aluminium tube (40–85 cm)
- Big operating range (6,5 m connection cable)
- Switchable floor brush
- Easy to clean
- Low weight
- Incl. wall mount (space saving)
- Accessories: Two part aluminium tube, wall mount, brush tool, crevice tool, floor brush
- 230 V, 50 Hz, 600 W max.
- W x H x D approx. 135 x 220 x 330 mm



Incl. floor brush (switchable)

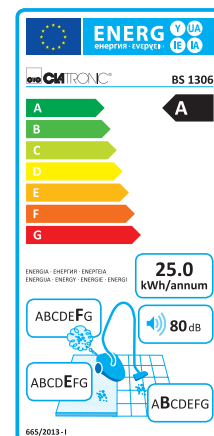

● Art. no. 263 776
EAN 4 006 160 637 762 PU 1



● Art. no. 263 779
EAN 4 006 160 637 793 PU 2
● Art. no. 263 778
EAN 4 006 160 637 786 PU 2





A

NEW! Floor vacuum cleaner
BS 1303

- Floor vacuum cleaner with energy-saving 700 watt
 - 4-fold microfilter system
 - Metal telescopic tube
 - Switchable floor brush
 - Dust bag change indicator
 - Practical carrying handle
 - Automatic cable rewind
 - Space-saving parking aid
 - Dual accessory: combined brush/crevice nozzle
- 220–240 V, 50/60 Hz, 700 W
■ WxHxD approx. 245 x 229 x 316 mm

Spare bags:

SSB 101
Art. no. 282 047
EAN 4 006 160 820 478

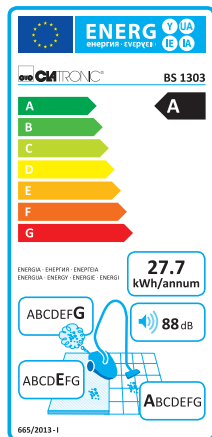

A

Floor vacuum cleaner
BS 1300

- Floor vacuum cleaner with energy-saving 700 watt
 - 5-layer micro-filter system
 - Stainless steel suction tube
 - Switchable floor brush
 - Dust bag change indicator
 - Practical carrying handle
 - Automatic cable rewind
 - Space-saving parking aid
 - 2-fold accessories: combined brush/crevice nozzle
- 220–240 V, 50/60 Hz, 700 W
■ WxHxD approx. 256 x 205 x 310 mm

Spare bags:

SSB 98
Art. no. 282 193
EAN 4 006 160 821 932

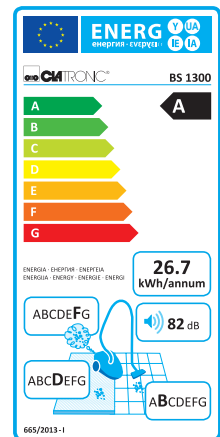



A **ELECTRONIC**



A **ELECTRONIC**

Floor vacuum cleaner
BS 1295

- Electronic power adjustment
- 4-layer micro-filter system
- Includes HEPA exhaust filter
- Stainless steel suction tube (approx. 84 cm length)
- Extra large operation range (approx. 8.30 m)
- Switchable floor brush
- Dust bag change indicator
- Rubberized rollers (ideal for sensitive floors)
- Practical carrying handle
- Automatic cable rewind
- Space-saving parking aid
- Integrated accessory tray
- 2-fold accessories: combined brush/crevice nozzle

- 220–240 V, 50/60 Hz, 800 W
- W x H x D approx.
255 x 205 x 370 mm

Spare bags:

SSB 101
Art. no. 282 193
EAN 4 006 160 820 932

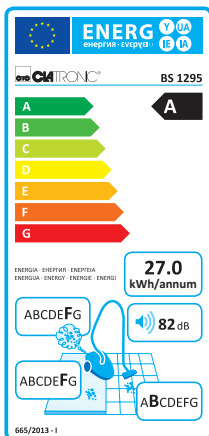

Floor vacuum cleaner
BS 1288

- Electronic power adjustment
- 4-layer micro-filter system
- Includes HEPA exhaust filter
- Stainless steel suction tube (approx. 85 cm length)
- Extra large operation range (approx. 8.30 m)
- Switchable floor brush
- Dust bag change indicator
- Rubberized rollers (ideal for sensitive floors)
- Practical carrying handle
- Automatic cable rewind
- Space-saving parking aid
- Integrated accessory tray
- 2-fold accessories: combined brush/crevice nozzle

- 230 V, 50 Hz, 800 W
- W x H x D approx.
280 x 240 x 460 mm

Spare bags:

SSB 101
Art. no. 282 047
EAN 4 006 160 820 478

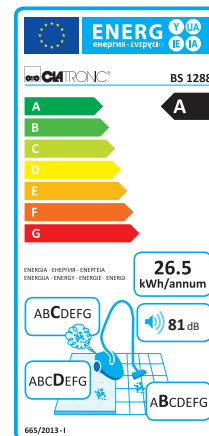

Art. no. 271 706
EAN 4 006 160 717 068

PU 1



Art. no. 271 701
EAN 4 006 160 717 013

PU 1





Floor vacuum cleaner
BS 1296

Floor vacuum cleaner
BS 1301

- Floor vacuum cleaner with energy-saving 700 watt
- Electronic power adjustment
- 4-layer micro-filter system
- Includes HEPA exhaust filter
- Stainless steel suction tube (approx. 84 cm length)
- Extra large operation range (approx. 8.30 m)
- Switchable floor brush
- Dust bag change indicator
- Rubberized rollers (ideal for sensitive floors)
- Practical carrying handle
- Automatic cable rewind
- Space-saving parking aid
- 2-fold accessories: combined brush/crevice nozzle

- 220–240 V, 50/60 Hz, 700 W
- WxHxD approx.
280 x 240 x 320 mm

Spare bags:

SSB 101
Art. no. 282 047
EAN 4 006 160 820 478

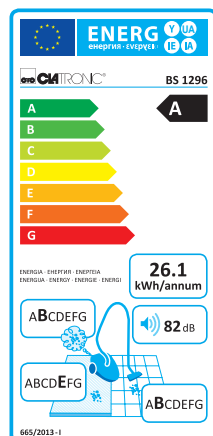

- Floor vacuum cleaner with energy-saving 700 watt
- Electronic power adjustment
- 5-layer micro-filter system
- Includes HEPA exhaust filter
- Stainless steel suction tube (approx. 84 cm length)
- Extra large operation range (approx. 8.30 m)
- Switchable floor brush
- Incl. parquet brush
- Dust bag change indicator (electronic)
- Rubberized rollers (ideal for sensitive floors)
- Practical carrying handle
- Automatic cable rewind
- Space-saving parking aid
- 3-fold accessories: crevice nozzle, upholstery nozzle, 360° brush attachment

- 220–240 V, 50/60 Hz, 700 W
- WxHxD approx. 291 x 246 x 457 mm

Spare bags:

SSB 101
Art. no. 282 047
EAN 4 006 160 820 478

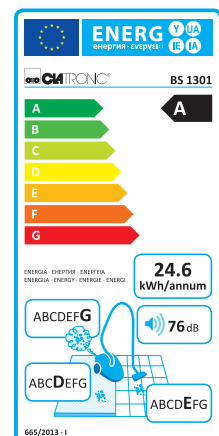

Art. no. 271 707
EAN 4 006 160 717 075

PU 1



Art. no. 271 713
EAN 4 006 160 717 136

PU 1





NEW! Floor vacuum cleaner
BS 1304

NEW! Floor vacuum cleaner
BS 1302

- Eco-Cyclon floor vacuum cleaner with energy-saving 700 Watt
- Bagless filter technology
- 4-fold microfilter system
- Includes HEPA filter
- Metal telescopic tube
- Switchable floor brush
- Rubberised rollers (ideal for sensitive floors)
- Practical carrying handle
- Automatic cable rewind
- Space-saving parking aid
- Dual accessory: combined brush/crevice nozzle
- 220–240 V, 50/60 Hz, 700 W
- W x H x D approx. 235 x 290 x 365 mm

- Eco-Cyclon twin spin floor vacuum cleaner with energy-saving 700 Watt
- Bagless Cyclon Twin Spin technique allows continual high suction power
- Electronic power adjustment
- 4-fold filter system
- Stainless steel telescopic tube (approx. 92 cm length)
- Extra-large operation range (approx. 8.30 m)
- Switchable floor brush
- Incl. parquet brush
- Rubberised rollers (ideal for sensitive floors)
- Practical carrying handle
- Automatic cable rewind
- Space-saving parking aid
- Dual accessory: combined brush/crevice nozzle
- 220–240 V, 50/60 Hz, 700 W
- W x H x D approx. 250 x 330 x 380 mm

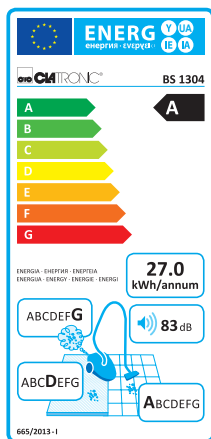

Incl. parquet brush

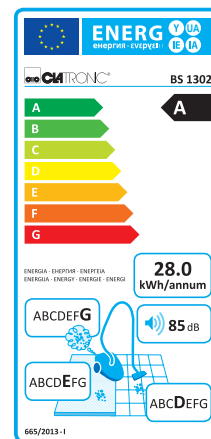

- Art. no. 271 716
EAN 4 006 160 717 167 PU 1
- Art. no. 271 718
EAN 4 006 160 717 181 PU 1
- Art. no. 271 717
EAN 4 006 160 717 174 PU 1

- Art. no. 271 719
EAN 4 006 160 717 198 PU 1
- Art. no. 271 720
EAN 4 006 160 717 204 PU 1
- Art. no. 271 721
EAN 4 006 160 717 211 PU 1





A   **ELECTRONIC**

2in1  **Stainless steel**

Floor vacuum cleaner
BS 1294

Wet and dry vacuum cleaner
BS 1285

- Floor vacuum cleaner with energy-saving 700 Watt
 - Electronic power adjustment
 - Includes 2 HEPA filter
 - Height-adjustable telescopic tube
 - Switchable floor brush
 - Bagless filtertechnology (no need to purchase dust bags)
 - Easy-to-empty, transparent dust-collecting container replaces conventional dust bag
 - Tank volume: 1.25 l
 - Motor protection filter (washable)
 - Rubberized rollers (ideal for parquet floors)
 - Automatic cable rewind
 - Space-saving parking aid
 - 3-fold accessories: combined brush/crevice nozzle, upholstery nozzle
- 220–240 V, 50/60 Hz, 700 W
 - W x H x D approx. 365 x 265 x 285 mm

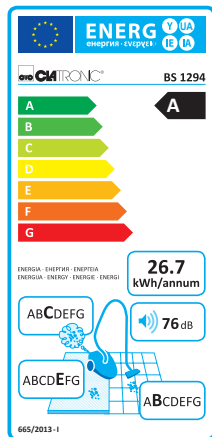

- Stainless steel housing
 - Large and comfortable wet and dry vacuum cleaner with powerful 1600 watt max.
 - Tank capacity: approx. 20 litre
 - Multi filter system
 - Incl. blower function, e.g. for easy removal of leaves
 - Draws coarse dirt as effectively as liquids
 - Optimal stability through 4 rollers
 - Deflection rollers (360°) allow smooth and flexible working
 - 2-part robust suction tube
 - Overflow protection by float valve
 - Practical holder on the vacuum cleaner for quick access and tidied accessory
 - 5 m cable allows large operation range
 - Accessories: brush/crevice nozzle, wet/dry brush, washable permanent filter
- 220–240 V, 50/60 Hz, 1600 W max.
 - W x H x D approx. 340 x 500 x 340 mm



Also ideal for the use on laminate, carpets etc.

Accessories: brush nozzle and crevice nozzle

Art. no. 271 711
EAN 4 006 160 717 112 PU 1
Art. no. 271 703
EAN 4 006 160 717 037 PU 1

Art. no. 271 686
EAN 4 006 160 716 863 PU 1





102

Textile cleaner MC 3240

- Ideal for the easy removal of lint/pilling
- Handy size
- Metal lint grid
- Transparent lint container
- On/off switch
- Battery operation: 2x 1.5 V (UM3) (batteries not included)
- WxHxD approx. 36 x 76 x 76 mm

Textile cleaner MC 3241

- Ideal for the easy removal of lint/pilling
- Handy size
- Metal lint grid
- Transparent lint container
- On/off switch
- Battery operation: 2x 1.5 V (UM3) (batteries not included)
- WxHxD approx. 60 x 85 x 170 mm

Luggage scale GW 3549

- Handy luggage scale
- Ergonomically designed
- Heavyduty tie-down straps
- Precise sensor measuring system
- Easily readable LCD display
- Promotional display packaging
- Measurement range up to 40 kg (subdivided into 100 g steps)
- Automatic switch-off
- On/off switch
- Battery operation: 1x CR2032 (battery included)
- WxHxD approx. 100 x 25 x 36 mm



Heavyduty tie-down straps



Promotional display box

Contents of the display box: 20 units

● Art. no. 263 063
EAN 4 006 160 630 633 PU 20



● Art. no. 263 062
EAN 4 006 160 074 314 PU 20



● Art. no. 263 623
EAN 4 006 160 636 239 PU 1





Electronic bathroom scale
PW 3368

- Electronic glass bathroom scale with easy-to-read LCD display
- Weighing units in kg, lb, st (convertible)
- Measurement range of 2.5–150 kg (subdivided into 100 g steps)
- Low-maintenance standing surface
- Non-slip feet ensuring secure base
- Automatic switch-off (prolongs battery life)

- Battery operation: 1x CR 2032 (battery not included)
- W x H x D approx. 330 x 300 x 250 mm

Electronic bathroom scale
PW 3369

- Electronic glass bathroom scale with easy-to-read LCD display
- Weighing units in kg, lb, st (convertible)
- Measurement range of 2.5–150 kg (subdivided into 100 g steps)
- Low-maintenance standing surface
- Non-slip feet ensuring secure base
- Automatic switch-off (prolongs battery life)

- Battery operation: 1x CR 2032 (battery not included)
- W x H x D approx. 320 x 320 x 25 mm



Digital thermometer FT 3617

FT 3618

Sterilizer BFS 3616

Baby food warmer BKW 3615

- Digital express thermometer with flexible measuring tip
 - Easily readable 3-digit LED display
 - Easy one-button operation
 - Precise body temperature measurement
 - Measurement range: 32 to 42.9 °C
 - Beep at the end of the measurement
 - Warning sound with a temperature above 37.8 °C
 - Automatic storage of the last value
 - Low-battery indication on the display
 - Free of mercury
 - Easy to clean
 - Protection cap for the sensor
 - Protected against splashing water
 - Automatic shutdown of the measuring function, increases the battery life time
 - Certified according to EN12470-3
 - Battery operation – 1x LR 41 (1,5 V) (batteries included)
 - W x H x D approx. 28 x 148 x 20 mm
- Gentle testing in the mouth
 - Easily readable 3-digit LCD display
 - Easy one-button operation
 - Precise body temperature measurement
 - Measurement range: 32 to 42.9 °C
 - Beep at the end of the measurement
 - Warning sound with a temperature above 37.8 °C
 - Automatic storage of the last value
 - Low battery indication on the display
 - Free of mercury
 - Easy to clean
 - Protection cap for the sensor
 - Protected against splashing water
 - Automatic shutdown of the measuring function, increases the battery life time
 - Certified according to EN12470-3
 - Battery operation (batteries included)
 - W x H x D approx. 60 x 40 x 40 mm
- Disinfection of up to 6 bottles and accessories
 - Removal of all harmful household bacteria
 - Up to 3 hours of "sterility" with unopened lid
 - Sterilization without chemical additives
 - Incl. removable bottle holder, gripper and measuring cup
 - Suitable for all standard bottles
 - Control lamp
 - 220–240 V, 50 Hz, 500 W
 - W x H x D approx. 205 x 320 x 195 mm
- Gentle and even warming of baby food
 - Suitable for standard bottles and glasses (up to 70 mm Ø)
 - Stepless temperature control from approx. 40 °C to 100 °C
 - Keep warm function
 - Accessory cup and lid
 - 220–240 V, 50 Hz, 100 W
 - W x H x D approx. 140 x 150 x 140 mm



Keep warm function



Incl. removable bottle holder, gripper and measuring cup



Gentle and even warming of baby food

Art. no. 263 714 PU 12
EAN 4 006 160 637 144



Art. no. 263 715 PU 12
EAN 4 006 160 637 151



Art. no. 263 713 PU 2
EAN 4 006 160 637 137



Art. no. 263 712 PU 3
EAN 4 006 160 637 120





Foot massager
FM 3389

- Intense whirlpool effect
- Massage burls for stimulating the foot reflex zones
- Additional massage roller, detachable, for selective foot reflex zone massage
- Heated footrest
- 4-level switches:
 - 0 = off
 - 1 = massage
 - 2 = warm/whirl
 - 3 = warm/whirl/massage
- Can be used with and without water
- Splash guard, detachable
- Water level mark
- Spout
- Large rubber feet for slip-proof stand

- 230 V, 50 Hz, 90 W
- WxHxD approx. 300 x 120 x 380 mm



Infra-red massaging rod
MSI 2571

- 3 functions:
 - massage only
 - infra-red only
 - massage and infra-red
- 4 different massage accessories:
 - 2 point concentrators
 - surface massager
 - face massager
- Extremely quiet motor

- 230 V, 50 Hz, 13 W
- WxHxD approx. 240 x 70 x 75 mm



4 different massage accessories

Manicure/pedicure set
MPS 2681

- Ergonomically shaped handle with on/off switch
- 8 different attachments:
 - 2 polishing attachments
 - 1 callus rasping attachment
 - 2 nail file attachments (rough/fine)
 - 1 large grinding cone
 - 2 small grinding cones (peaked/blunt)
- Modeling stick
- Rechargeable battery
- With fully discharged battery the device can be used in mains operation immediately
- Charging indicator light
- Practical storage box

- Power supply:
 - Primary mains adapter: 100-240 V, 50/60 Hz
 - Output voltage: DC 2.4 V
 - Secondary mains adapter: 3.6 V (adapter output)
- Output current:
 - Secondary mains adapter: 500 mA
- Rechargeable battery:
 - battery pack 2.4 V, 600 mAh
- Protection class: II
- WxHxD approx. 210 x 70 x 150 mm





2in1

106

Nose and ear hair remover NE 3595

- Conveniently and simply removes troublesome hairs in the nose and ears
- Includes light for improved personal grooming
- Removable fine-steel shearing head for cleaning
- On/off switch
- Incl. covering cap for the shearing head
- Battery operation: 1x 1.5 V (AA) (batteries not included)
- WxHxD approx. 30 x 130 x 35 mm



Includes light for improved personal grooming



Promotional Packaging

Hair and beard trimmer HSM 3430

- Stainless steel precision shaving head for uniform haircut
- Stainless steel blade
- Stepless cutting length adjustment for efficient use of the comb attachments
- 4 comb attachments: 3, 6, 9, 12 mm
- Rubberized inlay for non-slip handling
- Accessories:
 - 4 comb attachments
 - Cleaning brush
 - Shearing head protection
 - Hanging loop
- 230–240 V, 50 Hz, 10 W max.
- WxHxD approx. 65 x 55 x 200 mm



Hair trimmer set HSM 3441 NE

- Hair and beard trimmer:**
- Stainless steel precision shaving head for uniform haircut
 - Stainless steel blade
 - Stepless cutting length adjustment for efficient use of the comb attachments
 - 4 comb attachments: 3, 6, 9, 12 mm
 - Soft touch inlay for non-slip handling
 - Accessories: 4 comb attachments, cleaning brush, shearing head protection, comb, hanging loop
 - 230–240 V, 50 Hz, 10 W max.
 - WxHxD approx. 65 x 55 x 200 mm
- Nose and ear hair remover:**
- Gently and comfortably removes unsightly nose and ear hair
 - Stainless steel shaving head, can be detached for cleaning
 - Incl. cap for shaving head
 - Battery operation: 1x 1.5 V (AA) (batteries not included)
 - WxHxD approx. 28 x 130 x 30 mm

Art. no. 263 687
EAN 4 006 160 636 871 PU 12



Art. no. 263 559
EAN 4 006 160 635 591 PU 12



Art. no. 263 571
EAN 4 006 160 635 713 PU 10





Battery



2in1

Battery



4in1

Hair and beard trimmer HSM/R 3313

- Battery mode
- Stainless steel precision shaving head for uniform haircut
- Adjustable cutting lengths – 3 mm (without comb attachment); 5, 9, 13, 16 mm (with comb attachment) – for professional working
- Removable comb attachment
- Mechanically folding shaving head for easy cleaning
- Easy to handle due to ergonomically shaped grip
- Soft touch handle inlay
- LED charge display
- Charging station/stand including rubberized feet for stability
- Includes six accessories: charging station/stand, mains charger, comb, cleaning brush, scissors, comb attachment
- Mains charger: 100–240 V, 50/60 Hz
Battery (NiMH): 800 mAh
- W x H x D approx. 50 x 190 x 50 mm



Men's shaver incl. nose/ ear hair remover HR 3236

- **Men's shaver:**
 - 2 level shaving system
 - Hair cutter
 - Removable double shaving head for the cleaning of the blades
 - Includes spare shaving foil, cleaning brush, oil, storage bag
- **Nose/ear hair remover:**
 - Stainless steel blade
 - Blade can be removed for cleaning under running water
 - Rotating shearing
- **General:**
 - Battery/AC adapter
 - On/off switch
 - Skid-proof handle area
 - Includes textile bag
- 100–240 V, 50/60 Hz, 3 W
- W x H x D approx. 56 x 150 x 40 mm



Multicurler 4 in 1 MC 3020

- 2 in 1 – hair smoother with interchangeable plates for wavy or smooth hair
- 2 in 1 – curling tongs and curling iron
- Ideal for fashionable hairstyles
- Curling tongs chrome-plated
- Removable brush attachment
- Turn-lock fastener for attachments
- On/off switch, indicator light
- Ergonomic design handle
- Cable attached via 360° turnable joint
- Overheating protection
- 230 V, 50 Hz, 20 W
- W x H x D approx. 315 x 76 x 41 mm

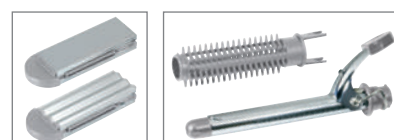

Art. no. 282 243
EAN 4 006 160 822 434 PU 10



Art. no. 273 498
EAN 4 006 160 734 980 PU 6



Art. no. 271 544
EAN 4 006 160 715 446 PU 12





108

Hair crimper HC 3392

- Hair crimper chromed
- Trouble-free styling due to the constant, long-lasting temperature
- Rapid heating
- Indicator light
- Soft touch housing
- Cable attached via 360° turnable joint
- On/off switch
- Incl. setting-down aid

- 230 V, 50 Hz, 25 W
- WxHxD approx. 280 x 35 x 70 mm

Hot air styler HAS 2712

- 2 power level
- Roll key for accessories
- Ergonomically formed
- Cable with swivel cord 360°
- Safety cut-out

- 230 V, 50 Hz, 300 W
- WxHxD approx. 320 x 50 x 50 mm

Hot air styler HAS 3019

- Powerful 550 watt motor
- 2 power level + cold level Cool Shot
- Incl. 3 accessories: volume styler, round brush, regular brush
- Roll-out button for attachments
- Switchable voltage
- Overheating protection

- 110/230 V, 50/60 Hz, 550 W
- WxHxD approx. 305 x 45 x 45 mm



Incl. volume styler, round brush, regular brush



Art. no. 263 183
EAN 4 006 160 631 838

PU 12



Art. no. 271 129
EAN 4 006 160 711 295

PU 12



Art. no. 271 548
EAN 4 006 160 715 484

PU 12





Hair dryer
HT 3393

- Compact travelling hair dryer
- 2 temperature/power settings
- Removable shaped nozzle, rotatable through 360°
- Rubber profile on the casing avoid slipping
- Overheating protection
- Hanging loop

- 230 V, 50 Hz, 1200 W
- WxHxD approx. 111 x 210 x 75 mm



Hair dryer
HT 3428

- Compact travelling hair dryer
- 2 temperature/power settings
- Soft touch housing – rubberized surface to prevent slipping when putting down
- Includes see-through bag for practical storage and when travelling
- Hanging loop

- 230 V, 50 Hz, 1200 W
- WxHxD approx. 150 x 210 x 75 mm



Hair dryer
HTD 3429

- Compact travelling hair dryer
- Folding handle
- 2 temperature/power settings
- Removable shaped nozzle, rotatable through 360°
- Soft touch housing – rubberized surface to prevent slipping when putting down
- Includes volume diffuser and see-through bag for practical storage and when travelling
- Switchable voltage: 110/230 V
- Hanging loop

- 230 V, 50 Hz, 1300 W max.
- WxHxD approx. 170 x 235 x 75 mm



110

Hair dryer
HTD 3614

- Professional hair dryer with powerful 2000 watt
- 3 temperature/power settings
- 2 speed level
- Cool Shot
- Professional volume diffuser and shaping nozzle
- Rubberized surface to prevent slipping when putting down
- Overheating protection
- Hanging loop

- 230 V, 50 Hz, 2000 W
- WxHxD approx. 210 x 235 x 90 mm

Professional hairstyler
HTD 3055 Profi

- Professional hairstyler with 2000 watt
- 3 temperature/power settings
- 2 speed level
- Cool Shot
- Professional volume diffuser and shaping nozzle
- Air intake filter (removable)
- Rubberized housing
- Avoid slipping
- Soft-touch grip
- Overheating protection
- Hanging loop

- 230 V, 50 Hz, 2000 W max.
- WxHxD approx. 270 x 270 x 90 mm



Ion technology function

Hair dryer HTD 2939

- Professional hairstyler with 2000 watt
- 2 temperature/power settings
- Cool Shot
- Professional finger diffuser and styling nozzle
- Air intake filter, removable
- Safety thermal cut-out
- Hanging loop

- 230 V, 50 Hz, 2000 W
- WxHxD approx. 260 x 240 x 90 mm

NEW! Hair dryer HT 3652

- Professional hair dryer with powerful 2100 watt
- Ion technology function – improved possibilities of hairstyling thanks to antistatic effect, the hair is not dried out and becomes smooth and shiny
- 3 temperature/power settings
- 2 speed settings
- Cool Shot
- Shaped nozzle, 360° swiveling (removable)
- LED pilot lamp
- Overheating protection
- Hanging loop

- 230 V, 50 Hz, 2100 W
- WxHxD approx. 220 x 255 x 90 mm

111



Ø 23 cm



Ø 30 cm

112

Table fan
VL 3601

- Oscillating (can be switched off)
- Adjustable angle of inclination
- Metal protection grid
- Safe base
- Ø approx. 23 cm
- 2 speed level
- 3-level switches (0-1-2)
- Practical carrying handle

- 220–240 V, 50/60 Hz, 30 W
- WxHxD approx. 275 x 375 x 220 mm

Table fan
VL 3602

- Oscillating (can be switched off)
- Adjustable angle of inclination
- Metal protection grid
- Safe base
- Ø approx. 30 cm
- 3 speed level
- 4-level switches (0-1-2-3)
- Practical carrying handle

- 220–240 V, 50/60 Hz, 40 W
- WxHxD approx. 340 x 480 x 245 mm

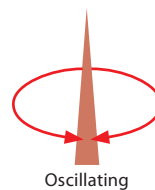
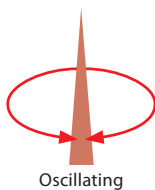

● **Art. no. 263 698**
EAN 4 006 160 636 987 PU 4



● **Art. no. 263 699**
EAN 4 006 160 636 994 PU 4





Ø 40 cm

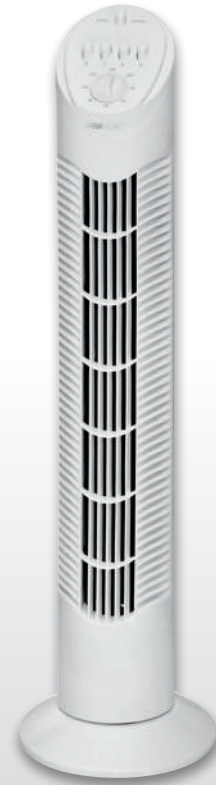

Standing fan
VL 3603 S

- Oscillating (can be switched off)
- Height-adjustable
- Adjustable angle of inclination
- Metal protection grid
- Safe base
- Ø approx. 40 cm
- 3 speed level
- 4-level switches (0-1-2-3)
- Practical carrying handle

- 220–240 V, 50/60 Hz, 45 W
- WxHxD approx. 430 x 1250 x 640 mm

Tower fan
T-VL 3546

- 75° oscillating (can be switched off)
- Space-saving
- Quiet running
- Protection grid
- Safe base
- 3 speed level
- 4-level switches (0-1-2-3)
- 120 minute timer
- Practical carrying handle
- Height: 76 cm

- 220–240 V, 50 Hz, 50 W
- WxHxD approx. 220 x 755 x 220 mm

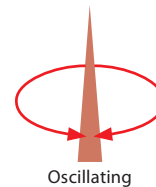
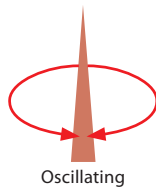

● **Art. no. 263 700**
EAN 4 006 160 637 007 PU 3



● **Art. no. 283 043**
EAN 4 006 160 830 439 PU 2





A



A

NEW! Air conditioning unit
CL 3637

- Cooling capacity: 7000 BTU (2.05 kW)
- Coolant: R 410 A
- Air recirculation: up to 380 m³/h
- 3 functions: cooling, dehumidifying, blowing
- Sound level: 65 dB(A)
- Energy efficiency class A
- 4x filters (removable)
- 24-hour timer
- Fan with 3 speed settings
- Multifunction LED display
- 4 easy-running rollers for easy transport
- Incl. infrared remote control
- Incl. 1.5 m exhaust hose and window kit

- 220–240 V, 50 Hz, 780 W
- WxHxD approx. 415 x 721 x 291 mm



Multifunction LED display



Incl. infrared remote control



Incl. exhaust hose

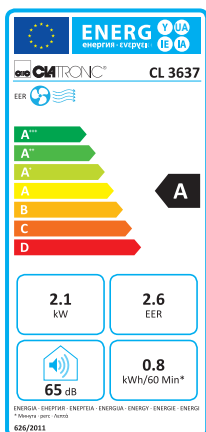

NEW! Air conditioning unit
CL 3639

- Cooling capacity: 8000 BTU (2.35 kW)
- Coolant: R 410 A
- Air recirculation: up to 380 m³/h
- 3 functions: cooling, dehumidifying, blowing
- Sound level: 65 dB(A)
- Energy efficiency class A
- 4x filters (removable)
- 24-hour timer
- Fan with 3 speed settings
- Multifunction LED display
- 4 easy-running rollers for easy transport
- Incl. infrared remote control
- Incl. 1.5 m exhaust hose and window kit

- 220–240 V, 50 Hz, 875 W
- WxHxD approx. 415 x 721 x 291 mm



Multifunction LED display



Incl. infrared remote control



Incl. exhaust hose



Art. no. 263 765
EAN 4 006 160 637 656 PU 1



Art. no. 263 767
EAN 4 006 160 637 670 PU 1





Convector heater KH 3077

- Mobile heat – also suitable for heating summerhouses, garages and conservatories
- 3 heat settings (750/1250/2000 W)
- Infinitely adjustable thermostat
- Automatic temperature controller
- Indicator light
- Convenient built-in carry handles for easy transport
- Low-noise operation
- Overheating protection
- Wall installation possible (installation material supplied)
- 220–240 V, 50Hz, 1900–2200 W
- W x H x D (without feet) 570 x 110 x 375 mm
- W x H x D (with feet) 570 x 195 x 420 mm

Convector heater KH 3433

- Mobile heat – also suitable for heating summerhouses, garages and conservatories
- 3 heat settings (750/1250/2000 W)
- Infinitely adjustable thermostat
- Automatic temperature controller
- Anti-frost function
- Includes blower function
- 3 control lamps
- Convenient built-in carry handles for easy transport
- Low-noise operation
- Overheating protection
- Wall installation possible (installation material supplied)
- 230 V, 50Hz, 2000 W
- W x H x D (without feet) 670 x 440 x 110 mm
- W x H x D (with feet) 670 x 480 x 110 mm



A+



A++



116

Cool box
KB 3537

- Suitable for cooling and warming
 - Perfect for camping, travel and shopping
 - Capacity (gross capacity): ca. 25 litre max.
 - Even cooling by integrated fan
 - Powerful, maintenance-free Peltier cooling/heating system
 - Energy saving function
 - Double walled plastic casing with high quality isolation
 - Special sealing rubber in the lid reduces condensation
 - Control lights for cooling and warming function
 - Foldable handle
 - Removable lid
 - Accessory: 12 V connecting cable (detachable), 230 V connecting cable (detachable)
- Power supply:
 - Mains adapter connection: DC 12 V, 40/48 W
 - Mains adapter connection: AC 220–240 V, ~ 50/60 Hz, 52/58 W, 11 W (ECO mode)
 - WxHxD approx. 405 x 435 x 300 mm
 - Energy class: A+



For all standard 0.75 / 1.0 / 1.5-litre bottles

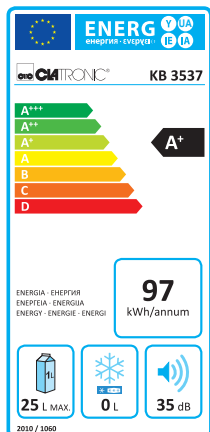

Cool box
KB 3538

- Suitable for cooling and warming
 - Perfect for camping, travel and shopping
 - Capacity (gross capacity): ca. 30 litre max.
 - Even cooling by integrated fan
 - Powerful, maintenance-free Peltier cooling/heating system
 - Energie saving function
 - Double walled plastic casing with high quality isolation
 - Special sealing rubber in the lid reduces condensation
 - Control lights for cooling and warming function
 - Foldable handle
 - Removable lid
 - Cable storage compartment
 - Accessory: 12 V connecting cable, 230 V connecting cable
- Power supply:
 - Mains adapter connection: DC 12 V, 40/48 W
 - Mains adapter connection: AC 220–240 V, ~ 50/60 Hz, 52/58 W, 8 W (ECO mode)
 - WxHxD approx. 405 x 435 x 300 mm
 - Energy class: A++



For all standard 0.75 / 1.0 / 1.5-litre bottles

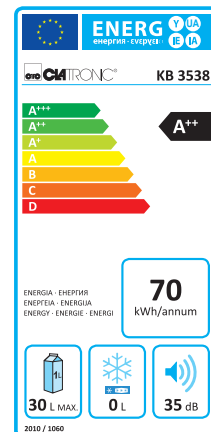

Art. no. 283 036
EAN 4 006 160 830 361 PU 1

CE

Art. no. 283 037
EAN 4 006 160 830 378 PU 1

CE



Air dehumidifier LE 3612

- Dehumidification power: 12 L/24 h
- Air circulation in m³:
- Level 1: approx. 100 m³/h
- Level 2: approx. 140 m³/h
- LED display (blue illuminated)
- Humidity indicator
- Electronic humidity control
- The desired humidity can be set from 40 to 80 %
- 24 hour timer
- 1 L water tank (detachable)
- Fold-out carrying handle
- Convenient rollers
- Automatic stop + warning signal with full tank
- Low noise
- Removable air filter (easy to clean)
- Hose connector for permanent water drain
- Incl. water hose (1 m)
- On/off switch
- Coolant: R134A
- Ideal for rooms up to 15 m²

- 220–240 V, 50 Hz, 220 W
- W x H x D approx. 280 x 520 x 185 mm

Fan heater HL 3378

- 2 heat settings (1000/2000 watt)
- Cold (ventilator)
- Infinitely adjustable thermostat
- Indicator light
- Safe base
- Sturdy carrying handle
- Overheating protection

- 220–240 V, 50 Hz, 2000 W
- W x H x D approx. 230 x 138 x 262 mm



LED display



Hose connector for permanent water drain



Fan heater
HL 3379

- 2 heat settings (1000/2000 watt max.)
- Cold (ventilator)
- Infinitely adjustable thermostat
- Indicator light
- 2 different ways of setting up
- Safe base
- Sturdy carrying handle
- Overheating protection

- 220–240 V, 50 Hz, 1800–2000 W
- WxHxD approx. 248 x 120 x 250 mm

Fan heater
HL 3377

- 2 heat settings (1000/2000 watt)
- Oscillating (can be switched off)
- Cold (ventilator)
- Infinitely adjustable thermostat
- Safety contact switch for fire protection
- Safe base
- Sturdy carrying handle
- Overheating protection

- 220–240 V, 50 Hz, 2000 W
- WxHxD approx. 235 x 300 x 205 mm



2 different ways of setting up

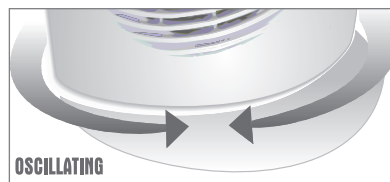

● Art. no. 271 672
EAN 4 006 160 716 726 PU 4



● Art. no. 271 670
EAN 4 006 160 716 702 PU 4





Ceramic fan heater
HL 3631

NEW! **Ceramic fan heater**
HL 3651

Insect killer
IV 3340

- PTC ceramic heater element for healthy, safe, quiet and efficient heating
 - Low dust accumulation
 - Quick and effective heating
 - Long service life
 - Robust and durable
 - 7 level switches
 - 2 heat settings (1000/1500 W)
 - Oscillating (can be deactivated)
 - Cold setting (fan blower)
 - Steplessly adjustable thermostat
 - Safety switch for fire protection
 - Stable stand
 - Robust carry handle (foldable)
 - Overheat protection
- 220–240 V, 50 Hz, 1500 W
 - W x H x D approx. 191 x 267 x 141 mm

- PTC ceramic heater element for healthy, safe, quiet and efficient heating
 - Low dust accumulation
 - Quick and effective heating
 - Robust and insensitive by durable ceramic heater
 - 4 level switches
 - 2 heat settings (1000/2000 W)
 - Adjustable angle of inclination (90°)
 - Cold setting (fan blower)
 - Steplessly adjustable thermostat
 - High stability due to sturdy metal frame
 - Robust carry handle
 - Overheating protection
- 220–240 V, 50 Hz, 2000 W
 - W x H x D approx. 210 x 217 x 160 mm

- Environmentally-friendly killing of mosquitoes/gnats/wasps/insects without chemicals or scents
 - The insects are attracted by the UV light and killed by means of an electric wire mesh.
 - Electric wire mesh voltage: 1500–2000 V on the mesh itself
 - Covers a range of approx. 20 m²
 - Specifically designed for use in closed rooms
 - All-round use
 - Same level of efficiency in daylight and artificial light
 - Includes suspension device
- 220–240 V, 50/60 Hz, 4 W
 - W x H x D approx. 160 x 230 x 100 mm



Oscillating

Art. no. 263 740
EAN 4 006 160 637 403

PU 4

Art. no. 263 775
EAN 4 006 160 637 755

PU 4

Art. no. 263 136
EAN 4 006 160 631 364

PU 6





Filter sets

BS 1248 / BS 1294

Art. no. 282 906
EAN 4 006 160 829 068

PU 1

BS 1249

Art. no. 282 907
EAN 4 006 160 829 075

PU 1

BS 1253

Art. no. 282 914
EAN 4 006 160 829 143

PU 1

BS 1256

Art. no. 271 596
EAN 4 006 160 715 965

PU 1

BS 1273 / BS 1281

Art. no. 282 918
EAN 4 006 160 829 181

PU 1

BS 1276

Art. no. 812 499
EAN 4 006 160 124 996

PU 1

BS 1280

Art. no. 8 912 800
EAN 4 600 160 128 000

PU 1

BS 1286

Art. no. 8 912 860
EAN 4 600 160 128 604

PU 1

BS 1293

Art. no. 8 912 937
EAN 4 600 160 129 373

PU 1

Dust bags

SSB 101

Suitable for:
BS 1267 / BS 1268 / BS 1271 / BS 1274 /
BS 1279 / BS 1288 / BS 1292 / BS 1296 /
BS 1301

Art. no. 282 047
EAN 4 006 160 820 478

PU 1

SSB 98

Suitable for:
BS 1264 / BS 1272 / BS 1284 / BS 1287 /
BS 1295 / BS 1300

Art. no. 282 193
EAN 4 006 160 821 932

PU 1

Replacement bottle / jars

**Replacement bottle for
Smoothie maker EF SM 3593**

Art. no. 264 559
EAN 4006 160 645 590

PU 6

**Replacement jars for
Yoghurt-Maker JM 3344**

Art. no. 251 125
EAN 4006 160 511 253

PU 4

120

Replacement
cartridges**Replacement cartridges DBS 3461**

Art. no. 8 934 610
EAN 4 006 160 632 583

PU 3

**Replacement cartridges
DBS 3611 / DBS 3634**

Art. no. 8 936 110
EAN 4 006 160 632 606

PU 3

Spare rolls
for bag sealer**FS 3261**

Art. no.: 890 0216
EAN 4 006 160 900 217

PU 10

TECHNICAL DATA FOR VACUUM CLEANERS Commission Delegated Regulation (EU) No. 665/2013

Clatronic							
Model		BS 1288	BS 1294	BS 1295	BS 1296	BS 1300	BS 1301
Energy efficiency class ¹⁾		A	A	A	A	A	A
Energy consumption							
Annual energy consumption ²⁾	kWh/year	26.5	26.7	27.0	26.1	26.7	24.6
Cleaning performance class							
Carpet cleaning performance class		D	E	F	E	D	D
Hard floor cleaning performance class		B	B	B	B	B	E
Dust re-emission class		C	C	F	B	F	G
Sound power level	dB(A) re 1pW	81	76	82	82	82	76
Rated input power	W	800	700	800	700	700	700

Clatronic							
Model		BS 1302	BS 1303	BS 1304	BS 1306		
Energy efficiency class ¹⁾		A	A	A	A		
Energy consumption							
Annual energy consumption ²⁾	kWh/year	28.0	27.7	27.0	25.0		
Cleaning performance class							
Carpet cleaning performance class		E	E	D	E		
Hard floor cleaning performance class		D	A	A	B		
Dust re-emission class		G	G	G	F		
Sound power level	dB(A) re 1pW	85	88	83	80		
Rated input power	W	700	700	700	max. 600		

¹⁾ A (highest efficiency) to G (lowest efficiency).

²⁾ Indicative annual energy consumption (kWh per year), based on 50 cleaning tasks.
Actual annual energy consumption will depend on how the appliance is used.

The device meets the European standards and directives in the current version at delivery:

- Low Voltage Directive (LVD) 2006/95/EC
- Electromagnetic Compatibility (EMC) Legislation Directive 2004/108/EC
- Ecodesign requirements for vacuum cleaners COMMISSION REGULATION (EU) No 666/2013

PRODUCT FICHE FOR AIR CONDITIONERS Commission Delegated Regulation (EU) No. 626/2011

Trademark	Clatronic		
Model	CL 3637		
Inside sound power level	L_{WA}	65	dB(A)
Refrigerant		R410A	
Global warming potential	GWP	2088	kgCO ₂ eq.
Refrigerant leakage contributes to climate change. Refrigerant with lower global warming potential (GWP) would contribute less to global warming than a refrigerant with higher GWP, if leaked to the atmosphere. This appliance contains a refrigerant fluid with a GWP equal to 2088. This means that if 1 kg of this refrigerant fluid would be leaked to the atmosphere, the impact on global warming would be 2088 times higher than 1 kg of CO ₂ , over a period of 100 years. Never try to interfere with the refrigerant circuit yourself or disassemble the product yourself and always ask a professional.			
Efficiency on the basis of energy efficiency ratio	EER_{rated}	2.60	
Energy efficiency class	A		
Energy consumption 0.788 kWh per 60 minutes, based on standard test results. Actual energy consumption will depend on how the appliance is used and where it is located.	Q_{SD}	0.788	kWh/60 min
Cooling capacity	P_{rated}	2.050	kW

Trademark	Clatronic		
Model	CL 3639		
Inside sound power level	L_{WA}	65	dB(A)
Refrigerant		R410A	
Global warming potential	GWP	2088	kgCO ₂ eq.
Refrigerant leakage contributes to climate change. Refrigerant with lower global warming potential (GWP) would contribute less to global warming than a refrigerant with higher GWP, if leaked to the atmosphere. This appliance contains a refrigerant fluid with a GWP equal to 2088. This means that if 1 kg of this refrigerant fluid would be leaked to the atmosphere, the impact on global warming would be 2088 times higher than 1 kg of CO ₂ , over a period of 100 years. Never try to interfere with the refrigerant circuit yourself or disassemble the product yourself and always ask a professional.			
Efficiency on the basis of energy efficiency ratio	EER_{rated}	2.60	
Energy efficiency class	A		
Energy consumption 0.883 kWh per 60 minutes, based on standard test results. Actual energy consumption will depend on how the appliance is used and where it is located.	Q_{SD}	0.883	kWh/60 min
Cooling capacity	P_{rated}	2.3	kW

TECHNICAL DATA FOR HOUSEHOLD REFRIGERATORS Commission Delegated Regulation (EU) No. 1060/2010

Clatronic			
Model	KB 3537	KB 3538	
Category¹⁾	10	10	
Energy efficiency class²⁾ A+++ (highest efficiency) to G (lowest efficiency)	A+	A++	
Consumption data			
Annual energy consumption³⁾	kWh	97	70
Net capacity cooling total	l	25	30
Net capacity freezing	l	0	0
Star rating⁴⁾		-	-
Frost-free		-	-
Temperature rise time	h	-	-
Freezing capacity	kg/ 24 h	-	-
Climate class⁵⁾	SN/N	SN/N	
Noise level	dB(A) re 1pW	35	35
Design		mobil	mobil

¹⁾ Category: 1 = Refrigerator with one or more fresh-food storage compartments, 2 = Refrigerator-cellar, Cellar and Wine storage appliances, 3 = Refrigerator-chiller and Refrigerator with a 0-star compartment, 4 = Refrigerator with a one-star compartment, 5 = Refrigerator with a two-star compartment, 6 = Refrigerator with a three-star compartment, 7 = Refrigerator-freezer, 8 = Upright freezer, 9 = Chest freezer, 10 = Multi-use and other refrigerating appliances.

²⁾ A+++ (highest efficiency) to G (lowest efficiency).

³⁾ Annual energy consumption „XYZ“ kWh per year based on standard test results for 24 h. Actual energy consumption will depend on how the appliance is used and where is located.

⁴⁾ * = compartment: a frozen-food storage compartment in which the temperature is not warmer than -6°C.

*** = compartment: a frozen-food storage compartment in which the temperature is not warmer than -18°C.

(*)*** = food freezer compartment in which the temperature is not warmer than -18°C and a minimum freezing capacity in 24 h.

⁵⁾ Climate class SN: ambient temperature of +10°C up to +32°C. Climate class N: ambient temperature of +16°C up to +32°C. Climate class ST: ambient temperature of +16°C up to +38°C. Climate class T: ambient temperature of +16°C up to +43°C.



Headquarter



Logistic Center (approx. 60.000 m²)



Showroom



Quality assurance



CTC Clatronic Int. GmbH
Industriering Ost 40
D-47906 Kempen
Phone +49 (0) 21 52/20 06-0
Fax +49 (0) 21 52/20 06-19 99
info@clatronic.de
www.clatronic.com

CTC Clatronic Sp. z o. o.
Ul. Opolska 1a, Karczów
PL-49-120 Dąbrowa
Phone +48 (0) 77/44 77 900
Fax +48 (0) 77/44 77 943
clatronic@clatronic.pl
www.clatronic.pl

CLATRONIC Far East Ltd.
Unit 1045, 47, 49, 49A, 10/F, KITEC
1 Trademart Drive,
Kowloon Bay
Kowloon, Hong Kong
info@clatronic.com.hk
www.clatronic.com.hk