

Home Appliances 2016





# CONTENT



Coffee machines	12
Coffee grinder	16
Espresso machine	16
Kettle	19
Milk frother	17
Tea/coffee station	23
Water kettle	22



Automatic toasters	24
Cake pop maker	29
Cotton candy maker	33
Chocolate fountain	34
Crêpe maker	28
Donut maker	28
Egg boiler	34
Ice cream maker	32
Ice cream cone maker	28
Ice cube maker	33
Muffin maker	29
Multigrill	31
Pepper/salt mill	35
Popcorn maker	34
Sandwich toaster	30
Soft ice cream maker	33
Waffle maker	26
Yogurt maker	33



Automatic juice extractor	54
Bag sealer	55
Bar mixer / milk frother	53
Can opener	57
Citrus fruit squeezer	52
Cook & Mix	49
Deep fat fryers	58
Electric knife	36
Fondue deep fat pan	58
Food dryer	56

Food processor	41
Food slicer	35
Hand blender	36
Hand blender set	37
Hand mixer	40
Hand mixer set	41
Kitchen scales	55
Kneading and stirring machine	42
Mincer	51
Multi express	38
Multi chopper	39
Smoothie maker	53
Universal mixer	51



Alcohol analyzer	84
Bread maker	62
Barbecue standing grill	71
Barbecue table grill	73
Built-in microwaves with grill	82
Contact grill	64
Convection oven	74
Electric grill lighter	70
Fondue set	68
Gas grill	72
Hot dog maker	63
Hotplates	84
Induction hot plates	85
Microwaves	78
Mini kitchen	77
Mini oven	75
Multi oven	76
Multi pizza oven	76
Teppanyaki grill	65
Pizza maker	75
Raclette grills	69
Rice boiler	61
Slow cooker	84
Steam cooker	63
Party pans	65



Steam irons	87
Fabric steamer	91
Mini-washing machine	91
Steam ironing unit	90
Travelling steam iron / steam brush	86



Battery vacuum cleaner	97
Floor vacuum cleaner	99
Hand vacuum cleaner	98
High-pressure cleaner	94
Steam cleaner	92
Steam mop	95
Table vacuum cleaner	97
Textile cleaner	104
Wet and dry cleaner	103
Window cleaner	96



Baby food warmer	106
Bathroom scales	104
Digital thermometer	106
Foot massage equipment	107
Hair and beard trimmer	108
Hair crimper / Hot air styler	110
Hair dryer	111
Hair straightener	109
Luggage scale	104
Manicure/pedicure set	107
Massage equipment	107
Men's shaver	109
Multicurler	110
Nose and ear hair remover	108
Sterilizer	106



Accessoires	122
Air conditioning unit	115
Air humidifier	118
Air dehumidifier	118
Convector heater	116
Cool boxes	117
Insect killer	120
Patio heater	121
Tower fan	115
Ventilators	114
Warm-air fan heater	119





**Universal mixer**  
UM 3561 => page 52

**Kettle**  
WK 3559 => page 21



**Automatic toaster**  
TA 3557 => page 25





**Multi chopper**

MZ 3560 => page 40



**Coffee machine**

KA 3558 => page 14





### Coffee machine KA 3552

- For 8–10 cups of coffee (approx. 1,25 l)
- Anti-drip protection
- Swivel filter
- On/off switch with control lamp
- Water level indicator
- Heating plate with automatic switch-off
- 230 V, 50 Hz, 870 W max.

### Automatic toaster TA 3551

- Compact 2-slice toaster
- Cool touch housing
- Bun warmer (removable)
- Defrost/reheat/quick-stop function
- Continuously adjustable thermostat
- 3 control lamps
- Automatic/manual switch-off
- Crumb drawer
- Cord storage
- 230 V, 50 Hz, 600–700 W. max.

### Kettle WK 3553

- Max. capacity 1.7 litre
- Simple handling due to cable free technology – easy to pour in and out
- Safety hinged lid
- Lime filter (removable)
- On/off switch (illuminated)
- Stainless steel heating element
- Automatic/manual switch-off
- External water level indicator
- Base station with cord storage
- Evaporation/overheating protection
- 230 V, 50 Hz, 2200 W



**Coffee machine**  
KA 3575

- For 8–10 cups of coffee (approx. 1.25 l)
- Stainless steel insert
- Anti-drip protection
- Filter holder (removable)
- On/off switch with control lamp (blue illuminated)
- Water level indicator
- Heating plate with automatic switch-off
- 230 V, 50 Hz, 1000 W



**Automatic toaster**  
TA 3574

- 2-slice toaster
- Stainless steel insert
- Cool touch housing
- Bun warmer (integrated)
- Defrost/reheat/quick-stop function
- Continuously adjustable thermostat
- 3 control lamps (blue illuminated)
- Centring function
- Automatic/manual switch-off
- Crumb drawer
- Cord storage
- 230 V, 50 Hz, 850 W



**Kettle**  
WKS 3576

- Max. capacity 1.5 litre
- Stainless steel insert
- Simple handling due to cable-free technology – easy to pour in and out
- 360° connector
- Lockable safety hinged lid with single-handed operation
- Lime filter (removable)
- On/off switch (blue illuminated)
- Concealed stainless steel heating element
- Automatic/manual switch-off
- 2 external water level indicators
- Base station with cord storage
- Evaporation/overheating protection
- 230 V, 50 Hz, 2200 W







### **Coffee machine** KA 3555

- For 8–10 cups of coffee (approx. 1,25 l)
- Anti-drip protection
- Swivel filter
- On/off switch with control lamp (blue illuminated)
- Water level indicator
- Heating plate with automatic switch-off
- 230 V, 50 Hz, 870 W max.



### **Automatic toaster** TA 3554

- Compact 2-slice toaster
- Cool touch housing
- Bun warmer (removable)
- Defrost/reheat/quick-stop function
- Continuously adjustable browning
- 3 control lamps (blue illuminated)
- Automatic/manual switch-off
- Crumb drawer
- Cord storage
- 230 V, 50 Hz, 870 W max.

### **Kettle** WK 3556

- Max. capacity 1.7 litre
- Simple handling due to cable-free technology – easy to pour in and out
- Safety hinged lid
- Lime filter (removable)
- On/off switch (blue illuminated)
- Stainless steel heating element
- Automatic/manual switch-off
- External water level indicator
- Base station with cord storage
- Evaporation/overheating protection
- 230 V, 50 Hz, 2200 W

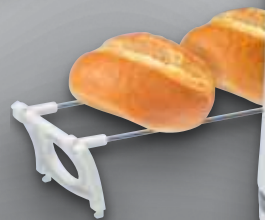

### **Coffee machine** KA 3555

- For 8–10 cups of coffee (approx. 1,25 l)
- Anti-drip protection
- Swivel filter
- On/off switch with control lamp (blue illuminated)
- Water level indicator
- Heating plate with automatic switch-off
- 220–240 V, 50/60 Hz, 730–870 W

### **Automatic toaster** TA 3554

- Compact 2-slice toaster
- Cool touch housing
- Bun warmer (removable)
- Defrost/reheat/quick-stop function
- Continuously adjustable browning
- 3 control lamps (blue illuminated)
- Automatic/manual switch-off
- Crumb drawer
- Cord storage
- 230 V, 50 Hz, 870 W max.

### **Kettle** WK 3556

- Max. capacity 1.7 litre
- Simple handling due to cable-free technology – easy to pour in and out
- Safety hinged lid
- Lime filter (removable)
- On/off switch (blue illuminated)
- Stainless steel heating element
- Automatic/manual switch-off
- External water level indicator
- Base station with cord storage
- Evaporation/overheating protection
- 230 V, 50 Hz, 2200 W



# Colour up



**Hand blender**  
SM 3577 => page 37



**Multi chopper**  
MZ 3579 => page 39



**Hand mixer**  
HM 3014 => page 40







**Glass kitchen scale**  
KW 3626 => page 55

**Smoothie maker**  
SM 3593 => page 53



*your  
life*



**Kettle**  
WK 3445 => page 19

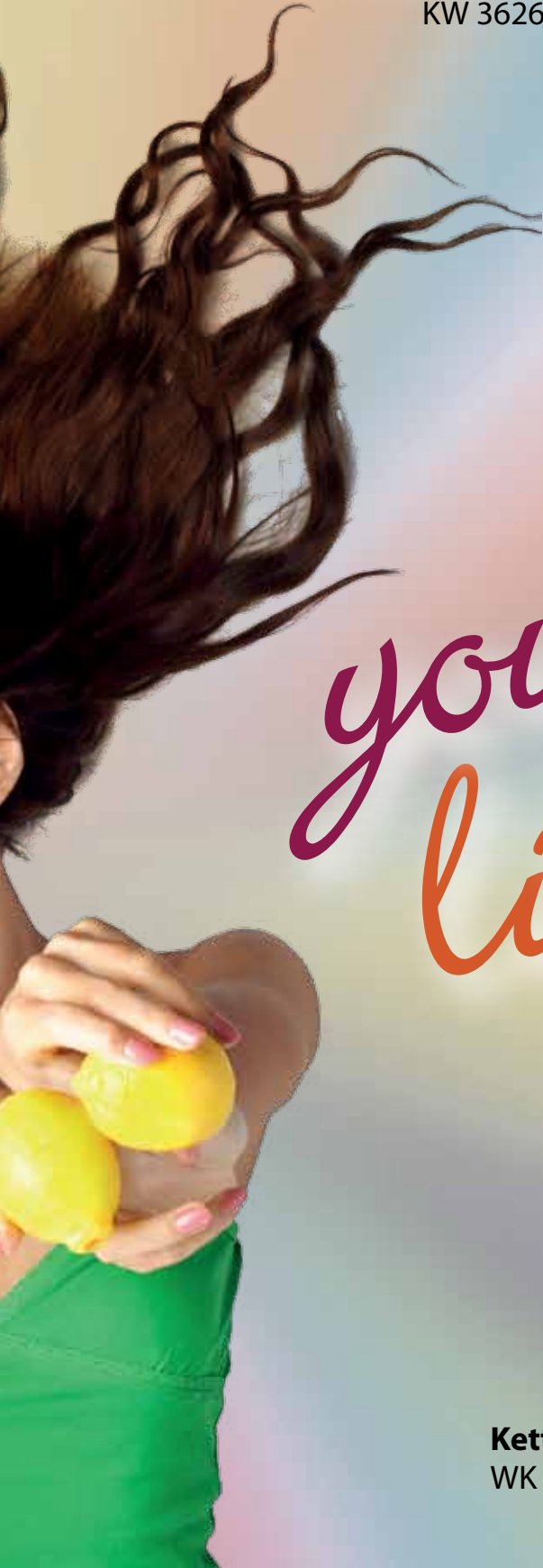



**1 cup coffee machine**  
KA 3356

- 1 cup coffee machine for filter coffee
- Space-saving design (ideal when out and about)
- Includes one ceramic cup
- Permanent nylon filter (removable)
- On/off switch with control lamp
- Automatic power off
- Nonslip tray (removable)
  
- 220–240 V, 50 Hz, 270–330 W
- W x H x D approx. 130 x 175 x 155 mm

**1-cup coffee machine**  
KA 3450

- „Coffee to go“ – simple, quick, and fresh, with the familiar taste of an aromatic filter coffee
- Ideal for camping, in the office, at home or on the way
- Incl. thermo stainless steel cup with drink opening and heat insulated aroma seal lid
- 300 ml capacity
- Permanent nylon filter (removable)
- Cup fits virtually all standard cup holders
- Rubberised „Soft Touch“ handle
- On/off switch
- Automatic power off
- Control lamp
  
- 230 V, 50 Hz, 420 W
- W x H x D approx. 165 x 160 x 245 mm

**Coffee machine**  
KA 3555

- For 8–10 cups of coffee (approx. 1,25 l)
- Anti-drip protection
- Swivel filter
- On/off switch with control lamp (blue illuminated)
- Water level indicator
- Heating plate with automatic switch-off
  
- 220–240 V, 50/60 Hz, 730–870 W
- W x H x D approx. 165 x 300 x 250 mm



Can also be combined as a suitable breakfast set

● Art. no. 263 155  
EAN 4 006 160 631 555 PU 6



● Art. no. 263 215  
EAN 4 006 160 632 156 PU 6



○ Art. no. 263 640  
EAN 4 006 160 636 406 PU 6  
● Art. no. 263 636  
EAN 4 006 160 636 369 PU 6





**Coffee machine**  
KA 3552

- For 8–10 cups of coffee (approx. 1,25 l)
- Anti-drip protection
- Swivel filter
- On/off switch with control lamp
- Water level indicator
- Heating plate with automatic switch-off
- 230 V, 50 Hz, 870 W max.
- W x H x D approx. 165 x 300 x 250 mm

**Coffee machine**  
KA 3473

- For 12–14 cups of coffee (approx. 1.5 l)
- Anti-drip protection
- Filter holder (removable)
- On/off switch (illuminated)
- Water level indicator
- Heating plate with automatic switch-off
- Cord storage
- 230 V, 50 Hz, 900 W
- W x H x D approx. 190 x 330 x 205 mm

**Coffee machine**  
KA 3509

- For 12–14 cups of coffee (approx. 1.5 l)
- Programmable 24-hour LCD digital timer
- Anti-drip protection
- Filter holder (removable)
- 4 control buttons
- Heating plate with automatic switch-off
- Water level indicator
- 2 control lamps
- 230 V, 50 Hz, 900 W max.
- W x H x D approx. 190 x 330 x 205 mm



Can also be combined as a suitable breakfast set



Programmable 24-hour LCD digital timer

● **Art. no. 263 632**  
EAN 4 006 160 636 314 PU 6

● **Art. no. 263 589**  
EAN 4 006 160 635 898 PU 6  
● **Art. no. 263 590**  
EAN 4 006 160 635 904 PU 6  
● **Art. no. 263 591**  
EAN 4 006 160 635 911 PU 6

● **Art. no. 261 692**  
EAN 4 006 160 616 927 PU 6







**Coffee machine**  
KA 3575

- For 8–10 cups of coffee (approx. 1.25 l)
- Stainless steel insert
- Anti-drip protection
- Filter holder (removable)
- On/off switch with control lamp (blue illuminated)
- Water level indicator
- Heating plate with automatic switch-off
- 230 V, 50 Hz, 1000 W
- W x H x D approx. 185 x 310 x 260 mm

**Coffee machine**  
KA 3562

- For 12–14 cups of coffee (approx. 1.5 l)
- High-quality stainless steel application
- Anti-drip protection
- Filter holder (removable)
- On/off switch with control lamp (blue illuminated)
- Water level indicator
- Heating plate with automatic switch-off
- 230 V, 50 Hz, 900 W
- W x H x D approx. 180 x 325 x 260 cm

**Coffee machine**  
KA 3558

- For 8–10 cups of coffee (approx. 1.2 l)
- Stainless steel insert and lid
- Anti-drip protection
- Filter holder (removable)
- On/off switch with control lamp
- Water level indicator
- Heating plate with automatic switch-off
- 230 V, 50 Hz, 900 W
- W x H x D approx. 195 x 335 x 220 mm



Can also be combined as a suitable breakfast set



Can also be combined as a suitable kitchen set

● Art. no. 263 653  
EAN 4 006 160 636 536 PU 6



● Art. no. 263 649  
EAN 4 006 160 636 499 PU 4



● Art. no. 263 644  
EAN 4 006 160 636 444 PU 4  
● Art. no. 263 647  
EAN 4 006 160 636 475 PU 4





**Coffee machine**  
KA 3482

- For 15 cups of coffee (approx. 1.7 l)
- Stainless steel front
- Programmable 24-hour LCD digital timer
- Anti-drip protection
- Filter holder (removable)
- 4 control buttons (illuminated)
- Heating plate with automatic switch-off
- Water level indicator
  
- 230 V, 50 Hz, 1000 W
- W x H x D approx. 220 x 375 x 240 mm

**Coffee machine**  
KA 3327

- For 8–10 cups of coffee (approx. 1 l)
- Thermo jug (double-walled)
- Anti-drip protection
- Filter holder (removable)
- On/off switch with control lamp
- Automatic power off
- Water level indicator
  
- 220–240 V, 50 Hz, 870 W max.
- W x H x D approx. 185 x 340 x 210 mm

**Coffee machine with jugs**  
KA 3328

- 2 jugs for 8–10 cups of coffee each (2 x 1 litre) – double-walled
- Anti-drip protection
- Filter holder (removable)
- On/off switch with control lamp
- Automatic power off
- Water level indicator
  
- 230 V, 50 Hz, 870 W max.
- W x H x D approx. 185 x 340 x 210 mm



Programmable 24-hour LCD digital timer

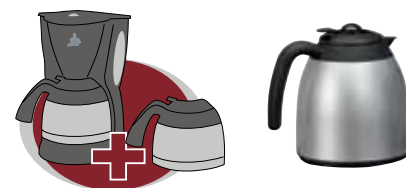

● Art. no. 261 665  
EAN 4 006 160 616 651

PU 4



● Art. no. 263 127  
EAN 4 006 160 631 272

PU 6



● Art. no. 263 126  
EAN 4 006 160 631 265

PU 4





16

### Thermo coffee machine KA 3563

- For 8–10 cups of coffee (approx. 1.2 l)
- Stainless steel thermo jug (double-walled) with aroma seal – drinks remain hot for longer
- High-quality stainless steel application
- Anti-drip protection
- Filter holder (removable)
- On/off switch with control lamp (blue illuminated)
- Automatic power off
- Water level indicator
- 220–240 V, 50 Hz, 800 W
- WxHxD approx. 180 x 325 x 260 cm



Double-walled thermo jug with aroma seal – drinks remain hot for longer

### Espresso machine ES 3584

- Espresso and cappuccino pump machine
- Swivelling stainless steel steam nozzle with foaming and hot water function
- Steam volume steplessly adjustable
- Steam nozzle tip removable for easy cleaning
- Cup warming function with aluminum insert
- Constant pump pressure (15 bar)
- 1.5 litre water tank (removable)
- External water level indicator
- Collection cup with aluminum drip grid (removable)
- 2 control lamps
- Automatic power off
- Ready status indicator
- Accessories: 2 filter holders (1 and 2 cups), coffee measure, tamper
- 230 V, 50 Hz, 1050 W
- WxHxD approx. 185 x 290 x 215 mm



Cup warming function

### Coffee grinder KSW 3306

- Electric coffee mill with beater
- Stainless steel beater blade
- Stainless steel bean container, hygienic and with aroma protection
- Transparent lid
- Capacity 40 g – for 20 cups of coffee
- With 120 watt motor
- Safety circuit – operation only possible with lid in place
- Safety pushbutton also for pulsed operation
- Degree of grinding can be selected by the length of operation
- Cord storage
- 230 V, 50 Hz, 120 W
- WxHxD approx. 100 x 200 x 100 mm

● Art. no. 263 650  
EAN 4 006 160 636 505

PU 4



● Art. no. 263 671  
EAN 4 006 160 100 831

PU 2



● Art. no. 283 023  
EAN 4 006 160 830 231

PU 6

● Art. no. 283 032  
EAN 4 006 160 830 323

PU 6







Stainless steel housing

**Coffee grinder**  
KSW 3307

- Electric coffee mill with beater
- Stainless steel beater blade
- Stainless steel bean container, hygienic and with aroma protection
- Transparent lid
- Capacity 40 g – for 20 cups of coffee
- With 120 watt motor
- Safety circuit – operation only possible with lid in place
- Safety pushbutton also for pulsed operation
- Degree of grinding can be selected by the length of operation
- Cord storage
- 230 V, 50 Hz, 120 W
- WxHxD approx. 100 x 200 x 100 mm



Cold and warm foaming function

**Glass milk frother**  
MS 3511

- No preheating of the milk thanks to the integrated heating function
- Creates foamy milk in seconds
- Also suitable for hot and cold chocolate
- Glass container (750 ml) with stainless steel handle
- Amount of milk foam: approx. 300 ml
- Simple handling due to cable-free technology, plug connection rotates through 360°
- Electronic 3 function switch
  - Froth the milk warm
  - Froth the milk cold – ideal for iced coffee
  - Heat the milk
- Built-in heating element
- Automatic switch-off function
- Incl. lid with splash guard function
- Additional stirrer hot drinks without foaming (e.g. cacao)
- Glass container and lid removable for easy cleaning
- 230 V, 50 Hz, 600 W
- WxHxD approx. 120 x 180 x 175 mm



Cold and warm foaming function

**Milk frother**  
MS 3326

- No preheating of the milk thanks to the integrated heating function
- Creates foamy milk in seconds
- Also suitable for hot and cold chocolate
- Mixing bowl (750 ml)
- Amount of milk foam: approx. 450 ml
- Simple handling due to cable-free technology, plug connection rotates through 360°
- Non-stick coated (inside/outside)
- Electronic 3 function switch
  - Froth the milk warm
  - Froth the milk cold – ideal for iced coffee
  - Heat the milk
- Built-in heating element
- Automatic switch-off function
- Incl. lid with splash guard function
- Mixing bowl and lid removable for easy cleaning
- 230 V, 50 Hz, 600 W
- WxHxD approx. 180 x 125 x 175 mm



ESPICCINO 



Stainless steel

18

**Milk frother**  
MS 3089

- Creates foamy milk in seconds
- Soft touch housing
- Stainless steel whisk
- Easy to clean
- Battery operation: 2 x 1,5 V AA/UM 3 (batteries not included)
- WxHxD approx. 47 x 225 x 32 mm

**Milk frother**  
MS 3502

- Creates foamy milk in seconds
- Easy handling due to cable-free technology
- Stainless steel housing
- Stainless steel frothing whisk
- Including stainless steel stand and closure cap for practical and hygienic storage
- LED control lamp (red illuminated)
- Detachable stainless steel cap (lockable)
- Battery operation: 2x 1.5 V (AA) (batteries not included)
- Length approx. 230 mm; Ø 32 mm

**NEW!** Travel kettle  
WKR 3624

- Ideal when traveling and on the move
- Max. capacity 0.5 litre
- Stainless steel housing
- Incl. 2 cups @ 170 ml, transport / travel bag and stainless steel spoon
- Concealed stainless steel heating element
- Control lamp
- Automatic switch-off
- Evaporation/overheating protection
- 110/230 V, 50 Hz, 1000 W
- WxHxD approx. 160 x 170 x 105 mm



Promotional Packaging



Incl. transport / travel bag



Incl. 2 cups à 170 ml + stainless steel spoon

- Art. no. 262 161  
EAN 4 006 160 621 617 PU 20
- Art. no. 263 230  
EAN 4 006 160 632 309 PU 20
- Art. no. 263 232  
EAN 4 006 160 632 323 PU 20
- Art. no. 263 231  
EAN 4 006 160 632 316 PU 20
- Art. no. 263 233  
EAN 4 006 160 632 330 PU 20



- Art. no. 261 674  
EAN 4 006 160 616 743 PU 10

- Art. no. 263 729  
EAN 4 006 160 637 298 PU 6





**Kettle**  
WK 3462

**Kettle**  
WK 3445

**NEW!** **Kettle**  
WK 3445

- Max. capacity 1.0 litre
  - Simple handling due to cable-free technology – easy to pour in and out
  - Safety hinged lid with single-handed operation
  - Lime filter (removable)
  - On/off switch (illuminated)
  - Stainless steel heating element
  - Automatic/manual switch-off
  - 2 external water level indicators
  - Rubber profile on the handle
  - Incl. base station
  - Evaporation/overheating protection
- 230 V, 50 Hz, 900 W  
■ WxHxD approx. 185 x 220 x 115 mm

- Max. capacity 1.7 litre
  - Simple handling due to cable-free technology – easy to pour in and out
  - Safety hinged lid with single-handed operation
  - Lime filter (removable)
  - On/off switch (illuminated)
  - Stainless steel heating element
  - Automatic/manual switch-off
  - 2 external water level indicators
  - Rubber profile on the handle
  - Base station with cord storage
  - Evaporation/overheating protection
- 230 V, 50 Hz, 2200 W  
■ WxHxD approx. 220 x 255 x 140 mm

- Max. capacity 1.7 litre
  - Simple handling due to cable-free technology – easy to pour in and out
  - Safety hinged lid with single-handed operation
  - Lime filter (removable)
  - On/off switch (illuminated)
  - Stainless steel heating element
  - Automatic/manual switch-off
  - 2 external water level indicators
  - Rubber profile on the handle
  - Base station with cord storage
  - Evaporation/overheating protection
- 230 V, 50 Hz, 2200 W  
■ WxHxD approx. 220 x 255 x 140 mm



Can also be combined as a suitable kitchen set

- Art. no. 263 229  
EAN 4 006 160 632 767 PU 6
- Art. no. 263 342  
EAN 4 006 160 633 429 PU 6

- Art. no. 263 210  
EAN 4 006 160 632 101 PU 6
- Art. no. 263 211  
EAN 4 006 160 633 118 PU 6
- Art. no. 263 212  
EAN 4 006 160 633 125 PU 6

- Art. no. 263 672  
EAN 4 006 160 636 727 PU 6
- Art. no. 263 673  
EAN 4 006 160 636 734 PU 6
- Art. no. 263 721  
EAN 4 006 160 637 212 PU 6
- Art. no. 263 674  
EAN 4 006 160 636 471 PU 6







20

### Kettle WK 3556

- Max. capacity 1.7 litre
  - Simple handling due to cable-free technology – easy to pour in and out
  - Safety hinged lid
  - Lime filter (removable)
  - On/off switch (blue illuminated)
  - Stainless steel heating element
  - Automatic/manual switch-off
  - External water level indicator
  - Base station with cord storage
  - Evaporation/overheating protection
- 230 V, 50 Hz, 2200 W  
■ W x H x D approx. 220 x 235 x 125 mm

### Kettle WK 3553

- Max. capacity 1.7 litre
  - Simple handling due to cable-free technology – easy to pour in and out
  - Safety hinged lid
  - Lime filter (removable)
  - On/off switch (illuminated)
  - Stainless steel heating element
  - Automatic/manual switch-off
  - External water level indicator
  - Base station with cord storage
  - Evaporation/overheating protection
- 230 V, 50 Hz, 2200 W  
■ W x H x D approx. 220 x 235 x 125 mm

### Kettle WK 3452

- Max. capacity 1.8 litre
  - Simple handling due to cable-free technology – easy to pour in and out
  - 360° connector
  - Lockable safety hinged lid with single-handed operation
  - Lime filter (removable)
  - On/off switch (illuminated)
  - Concealed stainless steel heating element
  - Automatic/manual switch-off
  - 2 external water level indicators
  - Base station with cord storage
  - Overheating protection
- 230 V, 50 Hz, 2200 W  
■ W x H x D approx. 225 x 255 x 150 mm



Can also be combined as a suitable breakfast set



Can also be combined as a suitable breakfast set

● Art. no. 263 641  
EAN 4 006 160 636 413 PU 6  
● Art. no. 263 637  
EAN 4 006 160 636 376 PU 6



● Art. no. 263 633  
EAN 4 006 160 636 338 PU 6



● Art. no. 263 217  
EAN 4 006 160 632 170 PU 6  
● Art. no. 263 227  
EAN 4 006 160 632 279 PU 6





Stainless steel

**Kettle**  
WKS 3576

- Max. capacity 1.5 litre
  - Stainless steel insert
  - Simple handling due to cable-free technology – easy to pour in and out
  - 360° connector
  - Lockable safety hinged lid with single-handed operation
  - Lime filter (removable)
  - On/off switch (illuminated)
  - Concealed stainless steel heating element
  - Automatic/manual switch-off
  - 2 external water level indicators
  - Base station with cord storage
  - Evaporation/overheating protection
- 230 V, 50 Hz, 2200 W  
■ W x H x D approx. 155 x 245 x 215 mm

**Kettle**  
WK 3559

- Max. capacity 1.7 litre
  - Simple handling due to cable-free technology – easy to pour in and out
  - 360° connector
  - Safety hinged lid with stainless steel insert and single-handed operation
  - Lime filter (removable)
  - On/off switch
  - Concealed stainless steel heating element
  - Automatic/manual switch-off
  - 2 external water level indicators (illuminated)
  - Base station with cord storage
  - Overheating protection
- 230 V, 50 Hz, 2200 W  
■ W x H x D approx. 220 x 235 x 160 mm

**Kettle**  
WKS 3381

- Max. capacity 1.0 litre
  - Stainless steel thermo housing
  - Simple handling due to cable-free technology – easy to pour in and out
  - 360° connector
  - Lockable safety hinged lid
  - Lime filter (removable)
  - On/off switch
  - Concealed stainless steel heating element
  - Automatic/manual switch-off
  - Water level indicator
  - Base station with cord storage
  - Evaporation/overheating protection
- 230 V, 50 Hz, 2200 W max.  
■ W x H x D approx. 220 x 195 x 150 mm



Can also be combined as a suitable breakfast set



Can also be combined as a suitable kitchen set

● **Art. no. 263 654**  
EAN 4 006 160 636 453 PU 6



● **Art. no. 263 645**  
EAN 4 006 160 636 451 PU 4  
● **Art. no. 263 648**  
EAN 4 006 160 636 482 PU 4



● **Art. no. 263 179**  
EAN 4 006 160 631 791 PU 6





Stainless steel

Stainless steel

Stainless steel

### Kettle WKS 3437

- Max. capacity 1.7 litre
- Simple handling due to cable-free technology – easy to pour in and out
- 360° connector
- Lockable safety hinged lid
- Lime filter (integrated)
- On/off switch (illuminated)
- Stainless steel body
- Concealed stainless steel heating element
- Automatic/manual switch-off
- Water level indicator
- Cord storage
- Evaporation/overheating protection
- 220–240 V, 50 Hz, 2000–2400 W max.
- WxHxD approx. 230 x 250 x 145 mm

### Kettle WKS 3288

- Max. capacity 1.7 litre
- Stainless steel thermo housing
- Simple handling due to cable-free technology – easy to pour in and out
- 360° connector
- Lockable safety hinged lid
- Lime filter (removable and washable)
- On/off switch
- Control lamp (blue illuminated)
- Concealed stainless steel heating element
- Automatic/manual switch-off
- 2 external water level indicators
- Base station with cord storage (stainless steel sheathed)
- Evaporation/overheating protection
- 230 V, 50 Hz, 2200 W max.
- WxHxD approx. 220 x 250 x 145 mm

### Water kettle WK 3564

- Max. capacity 1.8 litre
- Simple handling due to cable-free technology – easy to pour in and out
- 360° connector
- Lime filter (removable, washable)
- On/off switch
- Concealed stainless steel heating element
- Stainless steel water jug
- Automatic/manual switch-off
- External water level indicator
- Base station with cord storage
- Evaporation/overheating protection
- 230 V, 50 Hz, 1800 W
- WxHxD approx. 200 x 285 x 230 mm



External water level indicator

- Art. no. 263 567  
EAN 4 006 160 635 676 PU 6
- Art. no. 263 568  
EAN 4 006 160 635 683 PU 6
- Art. no. 263 569  
EAN 4 006 160 635 690 PU 6



- Art. no. 263 553  
EAN 4 006 160 625 530 PU 6
- Art. no. 263 090  
EAN 4 006 160 630 909 PU 6



- Art. no. 263 651  
EAN 4 006 160 632 774 PU 4







Stainless steel

3in1

**NEW!** Water kettle  
WKS 3625

Electric glass kettle  
WK 3501 G

Tea/coffee station  
TKS 3504

23

- Max. capacity 1.8 litre
- Simple handling due to cable-free technology – easy to pour in and out
- 360° connector
- Lime filter (removable, washable)
- On/off switch (illuminated)
- Concealed stainless steel heating element
- Stainless steel water jug
- Automatic/manual switch-off
- External water level indicator
- Base station with cord storage
- Evaporation/overheating protection

- 230 V, 50 Hz, 1850–2200 W
- WxHxD approx. 245 x 295 x 225 mm

- Max. capacity 1.7 litre
- Glass/stainless steel housing
- Water container made of heat resistant safety glass
- Simple handling due to cable-free technology – easy to pour in and out
- 360° connector
- On/off switch
- Concealed stainless steel heating element
- Automatic/manual switch-off
- External water level indicator
- Base station with cord storage (stainless steel sheathed)
- Evaporation/overheating protection

- 220–240 V, 50 Hz, 1850–2200 W max
- WxHxD approx. 220 x 240 x 150 mm

**3 in 1 – tea/coffee station with stainless steel water kettle and tea/coffee maker**

**Water kettle:**

- Max. capacity 1.7 litre
- Stainless steel water kettle with integrated heating element
- Simple handling due to cable-free technology – easy to pour in and out
- 360° connector
- On/off switch
- Lockable safety hinged lid
- Lime filter (integrated)
- Automatic/manual switch-off
- Water level indicator
- Evaporation/overheating protection

**Glass jug:**

- For tea and coffee making
- Max. capacity 1.2 litre
- Heat-resistant glass
- Stainless steel tea filter (removable)

**Base:**

- Keep warm function
- Heating plate (non-stick coated)
- On/off switch (illuminated)
- Heat insulated handles
- Non-slip stand
- 220–240 V, 50 Hz, 2000–2250 W max.
- WxHxD approx. 410 x 300 x 180 mm



External water level indicator

● Art. no. 263 727  
EAN 4 006 160 637 274 PU 4

● Art. no. 263 728  
EAN 4 006 160 637 281 PU 4

● Art. no. 261 675  
EAN 4 006 160 616 750 PU 4

● Art. no. 261 689  
EAN 4 006 160 616 897 PU 2





**Automatic toaster**  
TA 3565

- Compact 2-slice toaster
  - Cool touch housing
  - Bun warmer (integrated)
  - Defrost/reheat/quick-stop function
  - Continuously adjustable thermostat
  - 2 control lamps
  - Automatic/manual switch-off
  - Crumb drawer
  - Base station with cord storage
- 220–240 V, 50/60 Hz, 600–700 W
  - WxHxD approx. 285 x 240 x 165 mm

**Automatic toaster**  
TA 3554

- Compact 2-slice toaster
  - Cool touch housing
  - Bun warmer (removable)
  - Defrost/reheat/quick-stop function
  - Continuously adjustable thermostat
  - 3 control lamps (blue illuminated)
  - Automatic/manual switch-off
  - Crumb drawer
  - Cord storage
- 230 V, 50 Hz, 870 W max.
  - WxHxD approx. 260 x 170 x 145 mm

**Automatic toaster**  
TA 3551

- Compact 2-slice toaster
  - Cool touch housing
  - Bun warmer (removable)
  - Defrost/reheat/quick-stop function
  - Continuously adjustable thermostat
  - 3 control lamps
  - Automatic/manual switch-off
  - Crumb drawer
  - Cord storage
- 230 V, 50 Hz, 600–700 W. max.
  - WxHxD approx. 260 x 170 x 145 mm



Can also be combined as a suitable breakfast set



Can also be combined as a suitable breakfast set

- Art. no. 263 628  
EAN 4 006 160 636 284 PU 6
- Art. no. 263 629  
EAN 4 006 160 636 291 PU 6
- Art. no. 263 630  
EAN 4 006 160 636 307 PU 6



- Art. no. 263 639  
EAN 4 006 160 636 390 PU 6
- Art. no. 263 634  
EAN 4 006 160 636 345 PU 6



- Art. no. 263 631  
EAN 4 006 160 636 321 PU 6





Stainless steel housing

**Automatic toaster**  
TA 3574

**Automatic toaster**  
TA 3557

**NEW!** **Automatic toaster**  
TA 3620

- 2-slice toaster
  - Stainless steel insert
  - Cool touch housing
  - Bun warmer (integrated)
  - Defrost/reheat/quick-stop function
  - Continuously adjustable thermostat
  - 3 control lamps (blue illuminated)
  - Centring function
  - Automatic/manual switch-off
  - Crumb drawer
  - Cord storage
- 230 V, 50 Hz, 850 W
  - W x H x D approx. 300 x 175 x 170 mm

- 2-slice toaster
  - Stainless steel insert
  - Cool touch housing
  - Bun warmer (removable)
  - Defrost/reheat/quick-stop function
  - Continuously adjustable thermostat
  - 3 control lamps
  - Centring function
  - Automatic/manual switch-off
  - Crumb drawer
  - Cord storage
- 230 V, 50 Hz, 800 W
  - W x H x D approx. 285 x 160 x 170 mm

- 2-slice toaster
  - Stainless steel housing
  - Bun warmer (removable)
  - Defrost/reheat/quick-stop function (blue illuminated)
  - Continuously adjustable thermostat
  - Centring function
  - Automatic/manual switch-off
  - Crumb drawer
  - Cord storage
- 220–240 V, 50/60 Hz, 750–850 W
  - W x H x D approx. 270 x 180 x 150 mm



Can also be combined as a suitable breakfast set



Can also be combined as a suitable kitchen set



Defrost/reheat/quick-stop function (blue illuminated)

● **Art. no. 263 652**  
EAN 4 006 160 636 529 PU 6



● **Art. no. 263 643**  
EAN 4 006 160 636 437 PU 4  
● **Art. no. 263 646**  
EAN 4 006 160 636 468 PU 4



● **Art. no. 263 718**  
EAN 4 006 160 637 182 PU 4







26

### Automatic toaster TA 3534

- 4-slice long-slot toaster
  - Heat-insulated cool touch housing
  - Bun warmer (detachable)
  - Defrost/reheat/quick-stop function
  - Continuously adjustable thermostat
  - 3 LED control lamps
  - Automatic switch-off
  - Crumb drawer
  - Cord storage
- 230 V, 50 Hz, 1400 W
  - WxHxD approx. 375 x 175 x 165 mm

### Waffle maker WA 3491

- Large baking plates: approx. Ø 18 cm (non-stick coated)
  - Heat insulated handle
  - Continuously adjustable browning level
  - 2 control lamps for power and heating (baking lights)
  - High stability through rubberized feet
  - Overheating protection
- 220–240 V, 50 Hz, 1200 W
  - WxHxD approx. 205 x 115 x 250 mm

### Waffle maker WA 3492

- Stainless steel insert
  - Large baking plates: approx. Ø 18 cm (non-stick coated)
  - Heat insulated handle
  - Continuously adjustable browning level
  - 2 control lamps for power and heating (baking lights)
  - Overheating protection
- 230 V, 50 Hz, 1000 Watt
  - WxHxD approx. 260 x 100 x 260 mm



Stainless steel insert

● Art. no. 263 614  
EAN 4 006 160 636 147 PU 6



● Art. no. 261 679  
EAN 4 006 160 616 798 PU 6  
● Art. no. 261 680  
EAN 4 006 160 616 804 PU 6



● Art. no. 261 681  
EAN 4 006 160 616 811 PU 4





**Waffle maker**  
WA 3606

- Waffle maker for Belgian waffles
- Stainless steel insert
- 2 large baking plates, approx. 21.5 x 13.5 cm each (non-stick coated)
- 2 waffles for each baking procedure
- Heat insulated handles
- Continuously adjustable browning level
- 2 control lamps for power and heating (baking lights)
- High stability through rubberized feet
- Overheating protection
- Safety shutdown
- Cord storage
  
- 230 V, 50 Hz, 800 W
- WxHxD approx. 225 x 115 x 200 mm

**Waffle maker**  
WA 3493

- 2 large baking plates (non-stick coated)
- 2 waffles for each baking procedure
- Heat insulated handle
- Continuously adjustable browning level
- 2 control lamps for power and heating (baking lights)
- High stability through rubberized feet
- Overheating protection
  
- 230 V, 50 Hz, 1400 W
- WxHxD approx. 340 x 115 x 240 mm

**Waffle maker**  
WA 3607

- Stainless steel insert
- 2 large baking plates (non-stick coated)
- 2 waffles for each baking procedure
- Heat insulated handle
- Continuously adjustable browning level
- 2 control lamps for power and heating (baking lights)
- High stability through rubberized feet
- Overheating protection
- Cord storage
  
- 220–240 V, 50 Hz, 1200 W
- WxHxD approx. 350 x 105 x 230 mm



Stainless steel insert



Stainless steel insert

● Art. no. 271 705  
EAN 4 006 160 717 051

PU 4



● Art. no. 261 682  
EAN 4 006 160 616 828

PU 4



● Art. no. 263 702  
EAN 4 006 160 637 021

PU 4





**Ice cream cone maker**  
HA 3494

- Large baking plate: approx. Ø 18 cm (non-stick coated)
- Heat insulated handle
- Continuously adjustable browning level
- 2 control lamps for power and heating (baking lights)
- High stability through rubberized feet
- Incl. squirrel cone
- Overheating protection
  
- 220–240 V, 50 Hz, 1200 W
- W x H x D approx. 205 x 115 x 250 mm

**Crêpe maker**  
CM 3372

- Large baking plate: approx. Ø 29 cm (non-stick coated)
- Paper-thin crêpes, quickly and easily prepared
- Heat-insulated plastic base
- Continuously adjustable thermostat
- 2 control lamps for power and heating (baking lights)
- Base station with cord storage
- Incl. batter distributor
  
- 230 V, 50 Hz, 900 W
- W x H x D approx. 325 x 80 x 370 mm

**Donut maker**  
DM 3495

- For baking up to 7 bagels/donuts
- Baking surfaces non-stick coated
- Heat insulated handle
- 2 control lamps for power and heating (baking lights)
- Excellent stability through rubberized feet
- Overheating protection
  
- 230 V, 50 Hz, 900 W
- W x H x D approx. 225 x 115 x 225 mm



Incl. squirrel cone



Incl. batter distributor

● Art. no. 261 683  
EAN 4 006 160 616 835

PU 6



● Art. no. 251 121  
EAN 4 006 160 511 215

PU 4



● Art. no. 261 684  
EAN 4 006 160 616 842

PU 6







Incl. recipe ideas

3in1

Incl. recipe ideas

**Muffin maker**  
MM 3496

**Cake pop maker**  
CPM 3529

**Donut, muffin & cake pop maker** DMC 3533

- For baking up to 7 muffins
- Muffin diameter approx. 4.5 cm
- Baking surfaces non-stick coated
- Heat insulated handle
- 2 control lamps for power and heating (baking lights)
- Excellent stability through rubberised feet
- Overheating protection
  
- 230 V, 50 Hz, 900 W
- WxHxD approx. 225 x 115 x 225 mm

- For baking up to 13 cake pops
- Baking surfaces non-stick coated
- Heat insulated handle
- 2 control lamps for power and heating (baking lights)
- Excellent stability through rubberised feet
- Overheating protection
- Incl. 50 cake pop sticks
  
- 230 V, 50 Hz, 900 W
- WxHxD approx. 225 x 115 x 225 mm

- Baking up to 12 cake pops, 7 donuts or 7 muffins
- Baking surfaces non-stick coated and rechargeable
- Heat insulated handle
- 2 control lamps for power and heating (baking lights)
- High stability through rubberized feet
- Overheating protection
- Locking system
- Cord storage
- Incl. 50 cake pop sticks
  
- 230 V, 50 Hz, 700 W
- WxHxD approx. 208 x 120 x 265 mm



Incl. 50 cake pop sticks



Incl. 50 cake pop sticks



Baking up to 12 cake pops, 7 donuts or 7 muffins

● **Art. no. 261 685**  
EAN 4 006 160 616 859 PU 6

● **Art. no. 263 606**  
EAN 4 006 160 636 062 PU 6

● **Art. no. 263 613**  
EAN 4 006 160 636 130 PU 4





**Sandwich toaster**  
ST 3477

- Triangular sandwich plates
- Non-stick coating
- Heat insulated handle
- Automatic temperature controller
- 2 control lamps for power and heating (baking lights)
- Locking system
- Safety shutdown
- Overheating protection
  
- 220–240 V, 50 Hz, 750 W
- WxHxD approx. 230 x 80 x 230 mm

**Sandwich toaster**  
ST 3489

- Stainless steel insert
- Triangular sandwich plates
- Non-stick coating
- Heat insulated handle
- Automatic temperature control
- 2 control lamps for power and heating (baking lights)
- High stability through rubberized feet
- Locking system
- Overheating protection
- Cord storage
  
- 220–240 V, 50/60 Hz, 700 W
- WxHxD approx. 235 x 100 x 225 mm

**NEW!** **Sandwich toaster**  
ST 3628

- Stainless steel insert
- Triangular sandwich plates
- Non-stick coating
- Heat insulated handle
- Automatic temperature control
- 2 control lamps for power and heating (baking lights)
- High stability through rubberized feet
- Locking system
- Overheating protection
  
- 220–240 V, 50/60 Hz, 750 W
- WxHxD approx. 235 x 95 x 235 mm



Stainless steel insert



Stainless steel insert

- Art. no. 261 658  
EAN 4 006 160 616 583 PU 6
- Art. no. 261 659  
EAN 4 006 160 616 590 PU 6
- Art. no. 261 660  
EAN 4 006 160 616 606 PU 6



- Art. no. 261 677  
EAN 4 006 160 616 774 PU 6



- Art. no. 263 735  
EAN 4 006 160 637 359 PU 6





Stainless steel housing

3in1

**NEW!** Sandwich toaster  
ST 3629

Multi grill  
MG 3519

Multi grill  
ST/WA 3490

- 4-slice sandwich toaster
- Stainless steel insert
- Triangular sandwich plates
- Non-stick coating
- Heat insulated handle
- Automatic temperature control
- 2 control lamps for power and heating (baking lights)
- High stability through rubberized feet
- Locking system
- Overheating protection and overtemperature protection
- 220–240 V, 50/60 Hz, 1200 W
- WxHxD approx. 270 x 105 x 325 mm

- Multi grill for double-sided, fat-free grilling
- 700 watts
- Stainless steel housing
- Short cooking times
- Non-stick grill plates with extra deep grooves for strong grill pattern
- Heat insulated handle
- Control lamp
- Grilling surfaces: 23 x 14.5 cm
- Cord storage
- Versatile, can be used for e.g. panini, steaks, fish or vegetables
- 220–240 V, 50/60 Hz, 700W
- WxHxD approx. 270 x 95 x 230 mm

- Sandwich toaster, waffle maker and contact grill
- Versatile use by three different removable plates (sandwich/waffle/grill plates), e.g. for Belgian waffles and tasty sandwich variations, as well as for fast two-sided contact grilling
- Stainless steel insert
- Baking plates non-stick coated and changeable
- Heat insulated handle
- 2 control lamps for power and heating (baking lights)
- High stability through rubberized feet
- Locking system
- Overheating protection
- 230 V, 50/60 Hz, 650 W
- WxHxD approx. 230 x 100 x 225 mm



Stainless steel insert



Stainless steel housing



Stainless steel insert



Sandwich plates, waffle plates, grill plates

Art. no. 263 736  
EAN 4 006 160 637 366

PU 4

Art. no. 261 711  
EAN 4 006 160 617 115

PU 6

Art. no. 261 678  
EAN 4 006 160 616 781

PU 4





**Ice cube maker**  
EWB 3526

- Compact ice cube maker without complicated installation for producing ice cubes quickly and simply at the press of a button
- Ideal for home use, in offices, when camping or for small bars
- No water pipe required, simply fill water into the tank (2.2-l-water tank)
- Approx. 10–15 kg of ice cubes in 24 hours (approx. 90 g in 10 min – corresponding to 9 ice cubes)
- LED display and acoustic signal when the ice cube container is full or the water tank is empty
- Energy-saving mode – automatic switch-off at the end of the program
- On/off switch
- 3 control lamps (ice full, empty water, operation)
- Visual check through viewing window in the lid
- Low-noise
- 220–240 V, 50/60 Hz, 95 W (Cooling), 165 W (spending ice cubes)
- W x H x D approx. 245 x 330 x 370 mm



LED displays



For approx. 10–15 kg ice cubes



**Ice cream maker**  
ICM 3581

- Ice cream maker, suitable for preparing sorbet, ice cream and frozen yoghurt
- Lid with replenishing aperture
- For up to 1 kg of ice cream
- Preparation time 20–40 min.
- Mixer attachment and motor housing, removable for easy cleaning
- Double-walled ice cream maker with freezer pack
- Excellent stability through rubberized feet
- 220–240 V, 50 Hz, 12 W
- W x H x D approx. 205 x 230 x 230 mm



**Ice cream maker**  
ICM 3225

- Ice cream maker, suitable for preparing sorbet, ice cream and frozen yoghurt
- For up to 1 kg of ice cream
- Preparation time 20–40 min.
- Timer function
- Double-walled ice cream maker with freezer pack
- Mixer attachment with quiet, powerful synchronous motor
- Easy to clean
- 230 V, 50 Hz, 15 W
- W x H x D approx. 225 x 265 x 225 mm



● **Art. no. 261 712**  
EAN 4 006 160 617 122 PU 1



● **Art. no. 263 663**  
EAN 4 006 160 636 635 PU 2



● **Art. no. 263 045**  
EAN 4 006 160 630 459 PU 2







**Soft ice cream maker**  
ICM 3594

**Yogurt maker**  
JM 3344

**Cotton candy maker**  
ZWM 3478

- Soft ice cream maker with discharge valve for preparation of soft ice cream, ice cream, frozen yogurt, and sorbet
- Lid with replenishing aperture
- With portioner – ice dispensed directly from the machine
- On/off switch
- Incl. recipe suggestions
- Capacity max. 1 litre
- Double-walled ice cream maker with cold storage, removable for easy cleaning (H: 14 cm; Ø 17 cm)
- Stirring element with powerful, quiet motor
- Excellent stability through rubberised feet
  
- 220-240 V, 50 Hz, 18 W
- WxHxD approx. 220 x 440 x 225 mm

- Easy preparation of up to 1.1 litres of yoghurt
- 7 practical portion jars with screw cap (capacity: 160 ml)
- On/off switch (illuminated)
- Transparent lid
- Additional jars in a set of 6 also available as an optional  
EG JM 3344, Product number: 251 125
  
- 230 V, 50 Hz, 14 W
- WxHxD approx. 240 x 150 x 265 mm

- Large cotton candy bowl: Ø approx. 27 cm
- Transparent splash guard (removable)
- Dish and splash guard dishwasher safe
- Quartz heating element
- High stability due to suction feet
- Including measuring spoon and 10 wooden sticks
  
- 230 V, 50 Hz, 500 W
- WxHxD approx. 275 x 235 x 275 mm

**Suitable replacement jar:**  
EG JM 3344  
Art. no.: 251 125  
EAN: 4 006 160 511 253



Soft ice cream maker with discharge valve



Incl. wooden sticks

Art. no. 263 686  
EAN 4 006 160 636 864

PU 2

Art. no. 251 119  
EAN 4 006 160 511 192

PU 6

Art. no. 261 661  
EAN 4 006 160 616 613

PU 4





Stainless steel

Stainless steel

### Popcorn maker PM 2658

- Popcorn made by hot air circulation – less calories
- A healthy and tasty snack for the whole family
- Easy to make
- Preparation without oil
- On/off switch
- 230 V, 50 Hz, 900 W
- W x H x D approx. 160 x 300 x 140 mm

### Chocolate fountain SKB 3248

- Chocolate fountain for an exclusive buffet experience
- Stainless steel housing
- For dipping in various types of fruit/pastries
- Extra-smooth cascades for improved flow characteristics
- Deep drip collection bowl for long-lasting chocolate enjoyment
- Warm chocolate is transported by means of a worm shaft to the top of the fountain and then flows continuously down the fountain in gentle cascades
- Height-adjustable feet for a perfectly balanced flow of chocolate
- Stainless steel tower/fountain
- Stainless steel drip tray
- Motor and heating switchable separately by means of 2 switches
- Excellent stability through rubberised feet
- 230 V, 50 Hz, 170 W
- W x H x D approx. 215 x 395 x 215 mm



### Egg boiler EK 3321

- Preparation of up to 7 eggs
- Stainless steel housing
- Electronic hardness adjuster
- On/off switch (illuminated)
- Acoustic signal (buzzer)
- Removable egg holder
- Measuring beaker with egg pricker
- High quality steel hotplate
- 230 V, 50 Hz, 400 W
- W x H x D approx. 220 x 155 x 185 mm

Art. no. 262 847  
EAN 4 006 160 628 470

PU 8



Art. no. 262 695  
EAN 4 006 160 626 957

PU 4



Art. no. 263 118  
EAN 4 006 160 631 180

PU 4





**Egg boiler**  
EK 3497

**Electric pepper/salt mill**  
PSM 3004 N

**Food slicer**  
AS 2958

- Preparation of up to 6 eggs
- Heating dish (non-stick coated)
- On/off switch (illuminated)
- Acoustic signal (buzzer)
- Removable egg holder
- Incl. measuring beaker with egg pricker
- 230 V, 50 Hz, 400 W
- WxHxD approx. 220 x 130 x 135 mm

- High-quality precision ceramic grinder
- Stainless steel housing
- Adjustable ceramic grinder (from coarse to fine)
- Consistent grinding quality
- Simple refilling
- Single-handed operating
- Incl. light for optimum dosing of the condiment
- Battery-operated
- Battery operation:  
4x1,5 V AA/Mignon/LR/AM3 (batteries not included)
- WxHxD approx. 45 x 220 x 45 mm

- Special stainless steel blade (rustproof)
- Powerful motor
- 3-step switch
- Safety power switch
- Infinitely adjustable cutting thickness
- Cutting thickness indication
- Food holder with finger guard
- Removable slide
- Foldable housing
- 220–240 V, 50/60 Hz, 180 W max.
- WxHxD approx. 280 x 230 x 310 mm



● **Art. no. 261 686**  
EAN 4 006 160 616 866

PU 6



● **Art. no. 271 572**  
EAN 4 006 160 715 729

PU 6



● **Art. no. 262 532**  
EAN 4 006 160 625 325

PU 6





**Metal food slicer**  
MA 3585

- Big stainless steel blade (Ø 190 mm), rustproof
- Universal serrated blade
- Motor housing: aluminium die cast
- On/off switch
- Metal guiding rail
- Metallic guiding board
- Food grip with finger protection
- Continuously adjustable cutting size (0–15 mm)
- Tilted supporting table with stainless steel insert, tiltable for easy cleaning
- Non-slip stand by suction feet
- 220–240 V, 50/60 Hz, 150 W
- W x H x D approx. 365 x 235 x 265 mm



**Electric knife**  
EM 3062

- Serrated stainless steel blades (rustproof, dishwasher-safe)
- Powerful 180 watt max. motor
- Low-noise and low-vibration running
- Safety switch
- Safety slide switch
- 230 V, 50 Hz, 180 W max.
- W x H x D approx. 420 x 130 x 60 mm

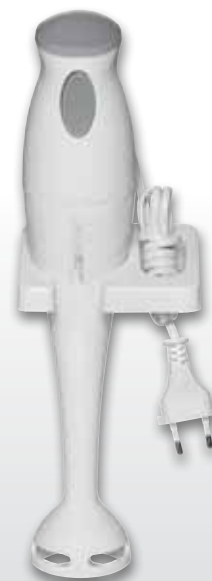

**Hand blender**  
SM 3081

- Stainless steel cutting blade
- On/off switch (countersunk)
- Incl. transparent mixing vessel (500 ml)
- Hanging loop
- Wall holder plus attachment materials
- 220–240 V, 50 Hz, 180 W
- W x H x D approx. 80 x 330 x 80 mm



Incl. transparent mixing vessel (500 ml)





Incl. transparent mixing vessel

3in1

**NEW!** Hand blender SM 3577

Hand blender SM 3282

Hand blender set SMS 3190

- Stainless steel cutting blade (rustproof)
- On/off switch (countersunk)
- Powerful 180 watt motor
- Incl. transparent mixing vessel (500 ml)
- Hanging loop
  
- 220–240 V, 50 Hz, 180 W
- W x H x D approx. 80 x 330 x 80 mm

- Stainless steel cutter
- Soft touch housing
- Powerful 300 watt motor
- 2-level pushbutton switch
- Removable stainless steel hand blender
- Ergonomic design handle
- Incl. mixing vessel with scale (0.6 litre)
  
- 230–240 V, 50 Hz, 300 W
- W x H x D approx. 65 x 370 x 65 mm

- Hand blender set – stainless steel hand blender, multiple chopper and whisk in one
- Working container with scale (0,5 litre)
- Powerful 200 watt motor
- 2 speeds
- Removable metal whisk
- Ergonomically shaped rubberised handle for easier handling
- Holder for metal whisk and stainless steel hand blender
- Incl. mixing vessel with scale (0.7 litre)
- Hanging loop
  
- 220–240 V, 50/60 Hz, 200 W
- W x H x D approx. 160 x 370 x 150 mm



Can also be combined as a suitable kitchen set



Incl. mixing vessel with scale (0.6 litre)



- Art. no. 263 635  
EAN 4 006 160 636 352 PU 8
- Art. no. 263 638  
EAN 4 006 160 636 383 PU 8
- Art. no. 263 724  
EAN 4 006 160 637 243 PU 8
- Art. no. 263 642  
EAN 4 006 160 636 420 PU 8

- Art. no. 263 111  
EAN 4 006 160 631 111 PU 6

- Art. no. 261 803  
EAN 4 006 160 618 037 PU 6





4in1

### Hand blender set SMS 3455

- Hand blender set (hand blender, whisk, ice-crusher, food processor)
- 7 functional options
- Stainless steel housing
- Powerful 750 watt motor
- Incl. ice-crush function
- Variable speed regulation (blue illuminated)
- Turbo setting for heavy applications
- Soft-touch press-button
- Ergonomically shaped, rubberized handle for easier handling
- Stainless steel mixing rod and metal whisk (detachable)
- Work container with scale and refill opening (1.25 litre capacity)
- High-grade, interchangeable attachments from stainless steel for chopping and grating
- Attachments: grating, cutting and potato-grating insert, chopper, transparent mixing container with scale (0.6 litre)
- Quick and easy assembly of the accessories
- 220–240 V, 50/60 Hz, 750 W
- W x H x D approx. 70 x 390 x 70 mm



Variable speed regulation



Incl. whisk



### Multi express ME 3604

- Electrical shredding unit "Multi Express"
- Large and changeable high-quality drum attachments made of stainless steel, for quick and easy cutting or grating
- Easy handling
- 5 functions:
  - cutting (fine/coarse) of, for example, onions, cucumbers
  - grating (fine/coarse) of, for example, carrots, radishes
  - shredding for example of parmesan, nuts, potatoes
- Powerful 150 W motor
- Large filler opening (ca. Ø 60 mm)
- Wide discharge opening (ca. Ø 80 mm)
- Accessories: 2 cutting attachments (fine/coarse), 2 grating attachments (fine/coarse), 1 shredding attachment
- 220–240 V, 50/60 Hz, 150 W
- W x H x D approx. 150 x 275 x 230 mm

Fine cutting  
e.g. onionsCoarse cutting  
e.g. cucumbersFine grating  
e.g. potatoesCoarse grating  
e.g. carrotsShredding  
e.g. parmesan

● Art. no. 263 223  
EAN 4 006 160 632 231

PU 4



● Art. no. 263 701  
EAN 4 006 160 637 014

PU 4





**2in1** Multi chopper & ice-crusher

**2in1** Multi chopper & ice-crusher

**2in1** Multi chopper & ice-crusher

**Multi chopper**  
MZ 3579

**NEW!** Multi chopper  
MZ 3579

**Multi chopper**  
MZ 3580

- Mixing bowl (1 litre capacity)
- Removable chopping blade (rustproof)
- Incl. ice-crusher function
- Safe base
- Easy to clean
- 220–240 V, 50/60 Hz, 250 W
- WxHxD approx. 175 x 220 x 175 mm

- Mixing bowl (1 litre capacity)
- Removable chopping blade (rustproof)
- Incl. ice-crusher function
- Safe base
- Easy to clean
- 220–240 V, 50/60 Hz, 250 W
- WxHxD approx. 175 x 220 x 175 mm

- Mixing bowl made of glass (1.2 litre capacity)
- Removable chopping blade (stainless steel, rustproof)
- 2-level pulse switching
- Incl. ice-crusher function
- Mixing bowl suitable for microwave oven
- Safe base
- Easy to clean
- 220–240 V, 50/60 Hz, 300 W
- WxHxD approx. 175 x 265 x 175 mm



Can also be combined as a suitable kitchen set

Art. no. 263 662  
EAN 4 006 160 636 628 PU 6

Art. no. 263 675  
EAN 4 006 160 636 758 PU 6  
Art. no. 263 676  
EAN 4 006 160 636 765 PU 6  
Art. no. 263 723  
EAN 4 006 160 637 236 PU 6  
Art. no. 263 677  
EAN 4 006 160 636 772 PU 6

Art. no. 263 661  
EAN 4 006 160 636 611 PU 6





**2in1**

**Multi chopper  
& ice-crusher**



**Hand mixer  
HM 3014**



**NEW!** **Hand mixer  
HM 3014**

**Multi chopper  
MZ 3560**

- Mixing bowl made of glass (1.2 litre capacity)
  - 2 removable chopping blades (stainless steel, rustproof)
  - Incl. ice-crusher function
  - Mixing bowl suitable for microwave oven
  - Stainless steel insert
  - Safe base
  - Easy to clean
- 220–240 V, 50 Hz, 300 W
  - WxHxD approx. 175 x 280 x 175 mm

- Powerful 250 watt motor
  - 5 speed level
  - Eject button
  - Stainless steel dough hooks and beaters
  - All accessories are dishwasher-safe
- 230 V, 50 Hz, 250 W
  - WxHxD approx. 180 x 280 x 90 mm

- Powerful 250 watt motor
  - 5 speed level
  - Eject button
  - Stainless steel dough hooks and beaters
  - All accessories are dishwasher-safe
- 230 V, 50 Hz, 250 W
  - WxHxD approx. 180 x 280 x 90 mm



Can also be combined as a suitable kitchen set



Can also be combined as a suitable kitchen set

- **Art. no. 263 624**  
EAN 4 006 160 636 246 PU 6
- **Art. no. 263 667**  
EAN 4 006 160 636 673 PU 6



- **Art. no. 262 147**  
EAN 4 006 160 621 471 PU 6



- **Art. no. 263 678**  
EAN 4 006 160 636 789 PU 6
- **Art. no. 263 679**  
EAN 4 006 160 636 796 PU 6
- **Art. no. 263 726**  
EAN 4 006 160 637 267 PU 6
- **Art. no. 263 680**  
EAN 4 006 160 636 802 PU 6







2in1



2in1

**Hand mixer set**  
HM 3524

- Powerful 300 watt motor
- 5 speed level
- Turbo setting
- Eject button
- Stainless steel dough hooks and beaters (21 cm) (dishwasher-safe)
- 220–240 V, 50/60 Hz, 300 W
- WxHxD approx. 90 x 145 x 200 mm

**Hand mixer set**  
HMS 3320

- Powerful 220 watt motor
- 5 speed level
- Turbo setting
- Eject button
- Large mixing bowl, rotating (2.5 litre)
- Accessory: 2 beaters and 2 dough hooks (chrome plated)
- Silent running
- All accessories dishwasher-safe
- 230 V, 50/60 Hz, 220 W
- WxHxD approx. 270 x 330 x 200 mm

**Hand mixer set**  
HMS 2739

- Powerful 250 watt motor
- 5 speed level
- Turbo setting
- High-speed blender attachment
- With fine steel knife, stainless steel beaters and dough hooks
- Large mixing bowl with automatic drive
- All accessories dishwasher-safe
- 230 V, 50/60 Hz, 250 W
- WxHxD approx. 300 x 350 x 200 mm



Incl. quick blender



Incl. quick blender



1200 Watt



## Food processor KM 3610

- Variable electronic speed control + pulse function
  - Electronic timer function
  - 4.2 litre fine steel dish for max. 1,7 kg mixture preparation
  - Aluminium die-cast stirring hook – also enables the uniform mixing of sizeable quantities of dough
  - Aluminium die-cast dough hook – for heavy doughs, e.g. yeast or bread dough
  - Stainless steel whisk for light sponge cake and fluffy egg whites
  - Constant power through load-dependent, electronic speed control
  - 35° swivelling multifunction arm
  - Unlocking mechanism for multifunction arm
  - Safety circuit
  - Transparent splash protection lid (detachable)
  - Particularly easy to operate and clean
  - Non-slip stand by suction feet
  - Base station with cord storage
  - Quick-action chuck for holding the tools
- 220–240 V, 50 Hz, 600 W  
■ W x H x D approx. 365 x 309 x 220 mm

## Kneading and stirring machine KM 3400

- High-performance kneading machine with extra-powerful 1200 watt
  - 7 speed settings plus pulse (0-1-2-3-4-5-6)
  - 5 litre fine steel dish for max. 2 kg mixture preparation
  - Aluminium die-cast stirring hook – also enables the uniform mixing of sizeable quantities of dough
  - Aluminium die-cast dough hook – for heavy doughs, e.g. yeast or bread dough
  - Stainless steel whisk for light sponge cake and fluffy egg whites
  - Special robust gear mechanism
  - Constant power through load-dependent, electronic speed control
  - 60° swivelling multifunction arm
  - Unlocking mechanism for multifunction arm
  - Safety circuit
  - Particularly easy to operate and clean
  - Non-slip stand by suction feet
  - Quick-action chuck for holding the tools
- 220–240 V, 50/60 Hz, 1200 W  
■ W x H x D approx. 370 x 370 x 230 mm



● Art. no. 263 704  
EAN 4 006 160 637 045 PU 2



● Art. no. 263 197  
EAN 4 006 160 631 975 PU 1





**ELECTRONIC**

**1200 Watt**



**NEW!** Kneading and stirring machine  
KM 3632

- Powerful food processor/kneading machine with extra-powerful 1200 watt max.
  - 5-level switch (0-1-2-3-4)
  - 5 LED control lamps (blue illuminated)
  - 5.6 litre fine steel dish for max. 2.5 kg mixture preparation
  - Stainless steel bowl (rustproof)
  - Aluminium die-cast stirring hook – also enables the uniform mixing of sizeable quantities of dough
  - Aluminium die-cast dough hook – for heavy doughs, e.g. yeast or bread dough
  - Whisk made of stainless steel
  - Special robust gear mechanism
  - Electronic speed control
  - 35° swivelling multifunction arm
  - Unlocking mechanism for multifunction arm
  - Safety circuit (can only be operated with the lid in position or with cover)
  - Transparent splash protection lid
  - Particularly easy to operate and clean
  - Non-slip stand by suction feet
- 
- 220–240 V, 50 Hz, 1200 W max.
  - W x H x D approx. 390 x 350 x 280 mm



Electronic circuit



35° swivelling multifunction arm

● **Art. no. 263 741**  
EAN 4 006 160 637 410

PU 1

● **Art. no. 263 742**  
EAN 4 006 160 637 427

PU 1

● **Art. no. 263 743**  
EAN 4 006 160 637 434

PU 1





**2in1**



**ELECTRONIC**



**NEW!** Kneading and stirring machine set  
KM 3633 W

**Kneading and stirring machine set**

- Powerful food processor/kneading machine with extra powerful 1200 watts max.
  - 5-level switch (0-1-2-3-4)
  - 5 LED control lamps (blue illuminated)
  - 5.6 litre fine steel dish for max. 2.5 kg mixture preparation
  - Stainless steel bowl (rustproof)
  - Aluminium die-cast stirring hook – also enables the uniform mixing of sizeable quantities of dough
  - Aluminium die-cast dough hook – for heavy doughs, e.g. yeast or bread dough
  - Whisk made of stainless steel
  - Special robust gear mechanism
  - Electronic speed control
  - 35° swivelling multifunction arm
  - Unlocking mechanism for multifunction arm
  - Safety circuit (can only be operated with the lid in position or with cover)
  - Transparent splash protection lid
  - Particularly easy to operate and clean
  - Non-slip stand by suction feet
- 220–240 V, 50 Hz, 1200 W max.  
■ W x H x D approx. 390 x 350 x 280 mm



**Kitchen scale**

- Extra-flat digital kitchen scale
  - Weighing surface made of high-quality glass
  - Clearly legible LCD display
  - Weights up to 5 kg (1 g scaling)
  - Adjustable measuring units: g, lb-oz, ml, fl-oz
  - Automatic switch-off
  - On/off switch
  - Tare function (additive weighed function)
  - High stability through rubberized feet
  - Low battery indicator
- Battery-operated:  
1x CR 2032 (battery included)  
■ W x H x D approx. 150 x 17 x 220 mm



Electronic circuit



35° swivelling multifunction arm

● Art. no. 263 745  
EAN 4 006 160 637 458 PU 1







1200 Watt

35° swivelling  
multifunction arm



**NEW!** Food processor  
KM 3630

45

- High-performance kneading machine with extra-powerful 1200 watt
  - 8 speed level (0/1/2/3/4/5/6 + pulse function)
  - 6.2 litre fine steel dish for max. 3–4 kg mixture preparation
  - Aluminium die-cast stirring hook (non-stick coated) – also enables the uniform mixing of sizeable quantities of dough
  - Aluminium die-cast dough hook (non-stick coated) – for heavy doughs, e.g. yeast or bread dough
  - Stainless steel whisk for light sponge cake and fluffy egg whites
  - Special robust gear mechanism
  - Constant power through load-dependent, electronic speed control
  - 35° swivelling multifunction arm
  - Unlocking mechanism for multifunction arm
  - Safety circuit
  - Particularly easy to operate and clean
  - Non-slip stand by suction feet
  - Quick-action chuck for holding the tools
- 220–240 V, 50 Hz, 1200 W
  - W x H x D approx. 402 x 326 x 212 mm



● Art. no. 263 739  
EAN 4 006 160 636 397 PU 1





1200 Watt



46

## Food processor KM 3573

- High-performance kneading machine with extra-powerful 1200 watt
  - Variable electronic speed control + pulse function
  - 6.5 litre fine steel dish for max. 3–4 kg mixture preparation
  - Aluminium die-cast stirring hook (non-stick coated) – also enables the uniform mixing of sizeable quantities of dough
  - Aluminium die-cast dough hook (non-stick coated) – for heavy doughs, e.g. yeast or bread dough
  - Stainless steel whisk for light sponge cake and fluffy egg whites
  - Special robust gear mechanism
  - Constant power through load-dependent, electronic speed control
  - 35° swivelling multifunction arm
  - Unlocking mechanism for multifunction arm
  - Safety circuit
  - Particularly easy to operate and clean
  - Non-slip stand by suction feet
  - Quick-action chuck for holding the tools
- 220–240 V, 50 Hz, 1200 W
  - WxHxD approx. 460 x 331 x 233 mm



● Art. no. 263 627  
EAN 4 006 160 636 277

PU 1

● Art. no. 263 681  
EAN 4 006 160 636 819

PU 1

● Art. no. 263 682  
EAN 4 006 160 636 826

PU 1



Incl. mixer attachment



2in1

1200 Watt

**Food processor**  
KM 3588

- High-performance kneading machine with extra-powerful 1200 W
- Variable electronic speed control + pulse function
- 6.5 litre fine steel dish for max. 3–4 kg mixture preparation
- Glass mixing container with scale and filler opening 1.5 litre capacity
- Aluminium die-cast stirring hook (non-stick coated) – also enables the uniform mixing of sizeable quantities of dough
- Aluminium die-cast dough hook (non-stick coated) – for heavy doughs, e.g. yeast or bread dough
- Stainless steel whisk for light sponge cake and fluffy egg whites
- Special robust gear mechanism
- Constant power through load-dependent, electronic speed control
- 35° swivelling multifunction arm
- Unlocking mechanism for multifunction arm
- Safety circuit
- Particularly easy to operate and clean
- Non-slip stand by suction feet
- Quick-action chuck for holding the tools
- 220–240 V, 50 Hz, 1200 W
- WxHxD approx. 460 x 331 x 233 mm

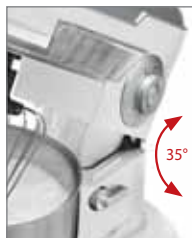

2in1



ELECTRONIC

**Kneading and stirring machine**  
incl. meat mincer KM 3414

- High-performance kneading machine with extra-powerful 1000 W
- 6-level switch (1-2-3-4-5-6)
- 7 LED control lamps, illuminated in blue
- 5 litre fine steel dish for max. 2 kg mixture preparation
- Aluminium die-cast stirring hook – also enables the uniform mixing of sizeable quantities of dough
- Aluminium die-cast dough hook – for heavy doughs, e.g. yeast or bread dough
- Stainless steel whisk for light sponge cake and fluffy egg whites
- Special robust gear mechanism
- Electronic speed control
- 35° swivelling multifunction arm
- Unlocking mechanism for multifunction arm
- Safety circuit
- Transparent splash protection lid, detachable
- Particularly easy to operate and clean
- Non-slip stand by suction feet
- Protective cover for drive axle

**Mincer**

- Stainless steel blades, metal refill tray, metal tube, metal cutter, 3 steel mincing disks (5/3/2 mm)
- Biscuit attachment, sausage filler accessory
- Kebbe attachment – oriental cuisine
- 220–240 V, 50 Hz, 1000 W
- WxHxD approx. 534 x 455 x 234 mm





4in1

## Food processor KM 3350

48

- Extra-powerful motor with max. 1000 watt
- 6 speed level plus pulsed operation
- 5 litre fine steel dish for max. 2 kg mixture preparation
- Mixing vessel with scale and filling aperture, 1.5 litre capacity
- Special kneading hook (spray protection) for yeast and bread dough
- Metal stirring hook with spray protection
- Metal whisk with spray protection
- Sturdy special gears
- Swivelling multi-function arm with unlocking mechanism
- Splash guard cover with filling aperture
- Particularly easy to operate and clean
- Safety circuit
- Non-slip stand by suction feet

### Mincer

- Metal tube, metal cutter, 3 steel mincing disks, stainless steel cutter, sausage filler accessory, biscuit attachment, metal refill tray

### Pasta maker

- Make pasta yourself with 5 different attachments, e.g. spaghetti, macaroni, tagliatelle
- Incl. box for storing the pasta attachments

- 220–240 V, 50/60 Hz, 1000 W max., 600 W nom.
- W x H x D approx. 250 x 575 x 400 mm



Pastamaker

Mixing  
accessory

Spaghetti attachment



Kneading and stirring



Mincer



Spaghetti attachment, narrow



Tagliatelle attachment



Lasagne sheets attachment



Penne-/Macaroni attachment

4in1





5in1



ELECTRONIC

Incl. recipe book



Cooking function

**Cook & mix**  
KM 3476

- 2000 watt max. (1100 watt motor / 900 watt heating/cooking)
- Incl. heating/cooking function, 900 watt
- 13 electronic speeds, 3 cooking programs, 10 speeds
- Stepless temperature setting 25°C to 140°C
- LCD display with blue illumination
- Digital temperature indication
- 60 minute timer
- 5.5 litre stainless steel bowl for max. 2 kg dough preparation
- Glass mixing container with scale and filler opening 1.5 litre capacity
- Incl. ice-crush function
- Special kneading hook (splash protection) for yeast and bread dough
- Metal stirring hook with splash protection
- Metal egg-whisk with splash protection
- Flexible stirring tool
- Robust special gears
- Swiveling multi-function arm with unlocking mechanism
- Splash guard lid with replenishing aperture
- User-friendly and easy to clean
- Safety circuit
- Stands securely through suction feet
- Cable storage compartment

**Mincer**

- Metal neck, metal screw, 3 steel mincing disks, stainless steel knife, sausage filler attachment, cookie attachment, metal filler tablet

- 220–240 V, 50/60 Hz, 2000 W max. (1100 watt motor max., 900 watt heating/cooking)
- WxHxD approx. 325 x 575 x 400 mm



Mincer



Mixing attachment



Digital temperature indication



Egg-whisk



Kneading function



Stirring function



Art. no. 263 588  
EAN 4 006 160 635 881 PU 1





50

### Food processor KM 3099

- Powerful kitchen machine with max. 550 watt motor
- 5 speed settings plus pulse (0-1-2-3-4)
- Mixing vessel with scale (1.5 litre capacity)
- High-quality, changeable utensils and work blades
- Safety switch
- Accessories: cutting disc, guillotine knife, kneading knife, grating disc, plastic spatula
- 220–240 V, 50 Hz, 550 W max.
- W x H x D approx. 380 x 380 x 250 mm

### Food processor KM 3333

- Powerful kitchen machine with 1000 watt motor
- 5 speed settings plus pulse (0-1-2-3-4)
- Mixing vessel with scale and filling aperture (1.5 litre capacity)
- Working container with scale and filling aperture (2.5 litre capacity)
- High-quality, changeable utensils and work blades
- Safety switch
- Accessories: scraper disc (fine + coarse), slicing blade (fine + coarse), potato peeler blade, french fry blade, dicing blade, kneader, beater emulsifying disc, dough scraper, tool holder, motor cover
- Non-slip stand by suction feet
- Cable take-up on the base
- 220–240 V, 50 Hz, 1000 W
- W x H x D approx. 425 x 425 x 255 mm



● Art. no. 262 977  
EAN 4 006 160 629 774 PU 2



● Art. no. 263 133  
EAN 4 006 160 631 333 PU 2





1000 Watt



1200 Watt



**Mincer**  
FW 3151

**Mincer**  
FW 3506

**Universal mixer**  
UM 3470

- Stainless steel insert
- Metal cutter
- Metal tube
- Metal filling tray
- Stainless steel cutter
- 3 steel mincing disks
- Reverse function
- Pastry attachment
- Sausage filler accessory
- Kebbe attachment – oriental cuisine
- On/off switch
  
- 220–240 V, 50 Hz, 1000 W max.
- W x H x D approx. 330 x 350 x 195 mm

- Chrome-plated front plate
- Metal neck
- Metal feed tray
- Metal feed screw
- 3 stainless steel discs (7/5/3 mm)
- Stainless steel knife
- Reverse function
- Cookie maker attachment
- Sausage filler accessory
- Kebbe attachment – oriental cuisine
- On/off switch
- Non-slip stand by suction feet
  
- 220–240 V, 50/60 Hz, 1200 W max.
- W x H x D approx. 330 x 355 x 170 mm

- Universal mixer for pureeing, beating, chopping, shaking and mixing
- Ideal for preparing fruit and fitness drinks, milk shakes, cocktails, soups, salsa sauces, baby food
- Ideal for kitchen and bar
- Ice crush function
- Powerful max. 500 watt motor
- 5 level switch (0-1-2-3-4 + pulse/ turbo function)
- Removable mixing bowl (1.5 litre capacity)
- Lid with replenishing aperture
- Cover for the filling aperture can also be used as a measuring beaker (2 cl)
- Stainless steel blade (rustproof)
- Safety circuit – operation only possible with vessel in place
- Excellent stability through rubberized feet
  
- 220–240 V, 50/60 Hz, 500 W max.
- W x H x D approx. 160 x 400 x 160 mm



Integrated storage compartment for accessories



Incl. 3 stainless steel discs, cookie maker attachment, kebbe attachment, sausage filler accessory



Incl. 3 stainless steel discs, cookie maker attachment, kebbe attachment, sausage filler accessory

● **Art. no. 263 315**  
EAN 4 006 160 633 153 PU 4

● **Art. no. 261 691**  
EAN 4 006 160 616 910 PU 4

● **Art. no. 263 583**  
EAN 4 006 160 635 836 PU 4





2in1

### Universal mixer UM 3561

- Universal mixer for pureeing, beating, chopping, shaking and mixing
  - Ideal for preparing fruit and fitness drinks, milk shakes, cocktails, soups, salsa sauces, baby food
  - Ideal for kitchen and bar
  - Stainless steel front
  - Incl. ice-crusher function
  - Powerful 600 watt motor
  - 4 level switch (0-1-2 + pulse/turbo function)
  - Removable mixing bowl made of solid glass with scale (1.5 litre capacity)
  - Lid with replenishing aperture
  - Cover for the filling aperture can also be used as a measuring beaker (5 cl)
  - 4-fold stainless steel blade (rustproof)
  - Safety circuit – operation only possible with vessel in place
  - Knife block removable for cleaning
  - Excellent stability through rubberised feet
- 220–240 V, 50/60 Hz, 600 W  
■ WxHxD approx. 185 x 410 x 200 mm



Can also be combined as a suitable kitchen set

● Art. no. 263 625  
EAN 4 006 160 636 253 PU 4  
● Art. no. 263 668  
EAN 4 006 160 636 680 PU 4



2in1

Stainless steel

### Universal mixer UM 3284

- Stainless steel universal mixer for pureeing, beating, chopping up, shaking and mixing
  - Ideal for preparing fruit and fitness drinks, milk shakes, cocktails, soups, salsa sauces, baby food
  - Ideal for kitchen and bar
  - Stainless steel housing
  - Ice-crusher function
  - Powerful max. 650 watt motor
  - 4 level switch (0-1-2-impulse)
  - Rotary switch (blue illuminated)
  - Removable mixing vessel made of solid glass with 1.5 litre capacity (with scale)
  - Lid with replenishing aperture
  - Cover for the filling aperture can also be used as a measuring beaker (2 cl)
  - 6-fold stainless steel blade (rustproof)
  - Safety circuit – operation only possible with vessel in place
  - All accessories are dishwasher-resistant
  - Knife block removable for cleaning
  - Excellent stability through rubberised feet
  - Cable storage compartment in the base section
- 220–240 V, 50/60 Hz, 650 W max.  
■ WxHxD approx. 200 x 410 x 185 mm

● Art. no. 263 115  
EAN 4 006 160 631 159 PU 4







Mixing cup also suitable as drinking cup

2in1



**NEW!** Smoothie maker  
SM 3593

Bar mixer / milk frother  
BM 3472

Citrus fruit squeezer  
ZP 3066

- Universal mixer for pureeing, beating, chopping up, shaking and mixing, consisting of base, mixing cup and lid with drinking aperture
- "Mix & Go" – Mix your favorite shake in a few minutes. With the practical drinking aperture, you can take your freshly prepared shake with you to work, school or sports
- Ideal for preparing fruit and fitness drinks, milk shakes, cocktails, soups, salsa sauces, baby food
- Incl. recipe suggestions
- Incl. lid with drinking aperture
- Ideal for kitchen, bar and on the road
- Powerful motor, 250 W
- 1 speed (pulse)
- Detachable mixing container (600 ml)
- Stainless steel blade (rustproof)
- Safety circuit – operation only possible with vessel in place
- All accessories dishwasher safe
- Excellent stability through rubberized suction pads
- 220–240 V, 50 Hz, 250 W
- WxHxD approx. 130 x 370 x 125 mm



Replacement bottle for  
Smoothie maker EF SM 3593

Art. no. 264 559 PU 6  
EAN 4 006 160 645 590 VE 6

- Bar mixer and milk frother
- Attractive chrome design
- Ideal for preparing fruit and fitness drinks, milk shakes, cocktails, salsa sauces, baby food
- Ideal for bar and kitchen
- Powerful 65 watt motor
- 2 speed level
- Stainless steel cup with a capacity up to 650 ml
- Convenient cup holder with safety circuit
- Stainless steel blender
- Excellent stability through rubberized feet
- 230 V, 50 Hz, 65 W
- WxHxD approx. 135 x 370 x 175 mm



Incl. practical cup holder

- Removable bowl with aroma protective cover (1.2 litre)
- 2 press cones
- Automatic start/stop function by pressing juicer cone
- Automatic clockwise/anticlockwise operation for optimal juice extraction
- Practical cable tidy
- 230 V, 50 Hz, 40 W
- WxHxD approx. 180 x 230 x 180 mm

- Art. no. 263 480 PU 6  
EAN 4 006 160 634 808
- Art. no. 263 688 PU 6  
EAN 4 006 160 636 888
- Art. no. 263 689 PU 6  
EAN 4 006 160 636 895

- Art. no. 263 722 PU 6  
EAN 4 006 160 637 229
- Art. no. 263 690 PU 6  
EAN 4 006 160 636 901

- Art. no. 263 585 PU 6  
EAN 4 006 160 635 850

- Art. no. 262 988 PU 6  
EAN 4 006 160 629 880





54

### Citrus fruit squeezer ZP 3253

- 2 press cones
- Automatic start/stop function by pressing juicer cone
- Automatic clockwise/anticlockwise operation for optimal juice extraction
- Unobstructed juice outflow
- Anti drip function
- 220–230 V, 50 Hz, 25 W
- WxHxD approx. 155 x 210 x 155 mm

### Automatic juicer AE 3531

- Powerful 400 watt max.
- Fresh fruit and vegetable juices quickly prepared. Rich in vital substances for well-being, fitness and health
- 30 % more juice and vitamins
- Removable pulp container
- Removable juice container
- On/off switch
- Lock with safety switch
- Stainless steel micro-strainer for finest juices
- Can be completely taken apart for rapid and unproblematic cleaning
- Safe stand
- 220–240 V, 50 Hz, 350–400 W max.
- WxHxD approx. 235 x 330 x 210 mm

### Professional automatic juicer AE 3532

- Professional automatic juicer in high-quality stainless steel housing
- Fresh fruit and vegetable juices quickly prepared. Rich in vital substances for well-being, fitness and health
- 30 % more juice and vitamins
- Extra large filler spout (75 mm Ø)
- Extracts the juice from apples, carrots and other fruits within seconds without having to chop them
- Powerful 1000 watt motor max.
- 2 speed settings (0-1-2) for different fruit hardness
- High volume pulp container (approx. 2.0 litre capacity)
- Open stainless steel juice spout
- Flexible anti-drip juice spout – no splashes and no wiping
- Lock with safety switch
- Stainless steel sieve for finest juices
- Can be completely disassembled – quick and easy cleaning
- High stability
- 230 V, 50 Hz, 1000 W max.
- WxHxD approx. 300 x 400 x 220 mm

● Art. no. 263 077  
EAN 4 006 160 630 770

PU 6



● Art. no. 263 608  
EAN 4 006 160 636 086

VE 4



● Art. no. 263 612  
EAN 4 006 160 636 123

PU 2





Stainless steel

Stainless steel

**NEW!** Glass kitchen scale  
KW 3626

Kitchen scale  
KW 3367

Kitchen scales  
KW 3412

- Extra-flat digital kitchen scale
  - Weighing surface made of high-quality glass
  - Clearly legible LCD display
  - Weights up to 5 kg (1 g scaling)
  - Adjustable measuring units: g, lb-oz, ml, fl-oz
  - Automatic switch-off
  - On/off switch
  - Tare function (additive weighed function)
  - High stability through rubberized feet
  - Low battery indication
- Battery-operated: 1 x CR 2032 (batterie supplied)  
■ W x H x D approx. 150 x 17 x 220 mm

- Extra-flat digital kitchen scale
  - Weighing surface made of stainless steel
  - Clearly legible LCD display
  - Weights up to 5 kg (1 g scaling)
  - Adjustable measuring units: kg, g, lb, oz
  - Automatic switch-off
  - On/off switch
  - Tare function (additive weighed function)
- Battery-operated: 2 x AAA (batteries not supplied)  
■ W x H x D approx. 150 x 20 x 180 mm

- Extra-flat digital kitchen scale
  - Weighing surface made of stainless steel
  - Clearly legible LCD display (blue illuminated)
  - Weights up to 5 kg (1 g scaling)
  - Adjustable measuring units: kg, g, lb, oz
  - Automatic switch-off
  - On/off switch
  - Tare function (additive weighed function)
  - Hanging loop (blue illuminated)
- Battery-operated: 3 x AAA (batteries supplied)  
■ W x H x D approx. 170 x 15 x 230 mm



Can also be combined as a suitable kitchen set

- Art. no. 263 730 PU 6  
EAN 4 006 160 637 304
- Art. no. 263 734 PU 6  
EAN 4 006 160 637 342
- Art. no. 263 733 PU 6  
EAN 4 006 160 637 335

- Art. no. 263 731 PU 6  
EAN 4 006 160 637 311
- Art. no. 263 732 PU 6  
EAN 4 006 160 637 328

- Art. no. 271 667 PU 6  
EAN 4 006 160 716 672

- Art. no. 271 680 PU 6  
EAN 4 006 160 716 801





 **Stainless steel**



**Kitchen scale**  
KW 3416

- Extra-flat digital kitchen scales with permanent clock and temperature information
- Stainless steel weighing surface
- Clearly legible, high-quality multifunction LCD display
- Weights up to 5 kg (1 g scaling)
- Adjustable measuring units: kg, g, lb, oz
- Automatic switch-off for weighing function
- On/off switch
- Tare function (additive weighed function)
  
- Battery-operated: 3 x AAA (batteries supplied)
- W x H x D approx. 160 x 18 x 230 mm

**Food dryer**  
DR 2751

- Food dryer dries fruit, vegetables, herbs, meat etc. Rich in essential minerals for well-being, fitness and health
- Variable use through 5 stackable level
- Circulating air blower, circulating air function
- On/off switch
- Overheating protection
  
- 230 V, 50 Hz, 250 W
- W x H x D approx. 285 x 160 x 315 mm

**Food dryer**  
DR 3525

- Food dryer dries fruit, vegetables, herbs, meat etc. Rich in essential minerals for well-being, fitness and health
- 2 temperature stages
- Variable use by 5 large, transparent, and stackable level (easy cleaning)
- Circulation fan, air circulation function
- Overheating protection
  
- 230 V, 50 Hz, 300 W
- W x H x D approx. 330 x 315 x 327 mm



5 stackable level



Variable use by 5 large, transparent, and stackable level (easy cleaning)

● **Art. no. 271 683**  
EAN 4 006 160 716 832 PU 6



● **Art. no. 261 767**  
EAN 4 006 160 617 672 PU 4



● **Art. no. 261 699**  
EAN 4 006 160 616 996 PU 4







**Can opener**  
DO 2852

- Ergonomically shaped handle
- One-hand operation
- Flexible magnet holder for lid of tin
- Removable blade
- Hanging loop
  
- 230 V, 50 Hz, 25 W
- WxHxD approx. 210 x 90 x 110 mm

**NEW!** **Can opener**  
DO 3627

- Flexible magnet holder for lid of tin
- Suitable for cans of up to max. 19 cm height
- Automatic start/stop function
- Detachable blade (easy cleaning)
- Inclusive:
  - Bottle opener
  - Blade sharpener (ceramic)
- Cord storage
- Secure stand
  
- 220-240 V, 50/60 Hz, 80 W
- WxHxD approx. 135 x 230 x 115 mm

**Bag sealer**  
FS 3261

- Ideal for dividing food into portions
- Electronically controlled bag sealer
- Seals and separates in one operation
- Strong extraction pump
- With bag storage view window
- 2 indicator lights
- Cord storage in base
- Incl. a roll of film (3 m)
  
- 230 V, 50 Hz, 100 W
- WxHxD approx. 330 x 80 x 125 mm

**Spare rolls:**

Art. no.	282 020	
EAN	4 006 160 820 201	PU 10
Art. no.	8900 216	
EAN	4 006 160 900 217	PU 10



Integrated bottle opener



Integrated knife sharpener (ceramic)



● **Art. no. 262 894**  
EAN 4 006 160 628 944 PU 6



● **Art. no. 263 737**  
EAN 4 006 160 637 373 PU 6



● **Art. no. 263 083**  
EAN 4 006 160 630 831 PU 6





2in1



58

**Fondue deep fat pan**  
FFR 2916

- Cool touch housing
- Capacity: 1 litre oil/frying fat
- Deep frying basket with removable handle
- Continuously variable thermostat
- Control panel with display
- 6 fondue forks marked in colour
- Protective ring against spray/fork holder
- Changeable odour and fumes filter
- Overheating protection
- 230 V, 50 Hz, 900 W
- W x H x D approx. 190 x 240 x 190 mm



**Deep fat fryer**  
FR 3390

- Cool touch housing
- Capacity: approx. 2 litre oil/frying fat
- Oil container with non-stick coating
- Large frying basket, can be raised and lowered with the lid closed
- Pop-up lid with viewing window (detachable)
- On/off switch (0-1)
- Continuously adjustable thermostat with control lamp
- 130°C–190°C
- 2 control lamps for power and heating
- Changeable odour and fumes filter
- Collecting container for condensation
- 2 recessed grips for safe transport
- 230 V, 50 Hz, 1800 W
- W x H x D approx. 245 x 260 x 320 mm



**Deep fat fryer**  
FR 2881

- Capacity: 2.2 litre oil/frying fat
- Large frying basket
- Spring lid, removable
- Continuously adjustable thermostat with control lamp
- 130°C–190°C
- 2 control lamps
- Changeable odour and fumes filter
- 230 V, 50 Hz, 1600 W max.
- W x H x D approx. 270 x 230 x 280 mm

Art. no. 282 232  
EAN 4 006 160 822 328

PU 4



Art. no. 263 180  
EAN 4 006 160 631 807

PU 2



Art. no. 282 868  
EAN 4 006 160 828 689

PU 2





Removable  
oil container



Removable  
oil container



Stainless steel



**Deep fat fryer**  
FR 3391

- Cool touch housing
- Capacity: 2.5 litre of oil/frying fat
- Removable oil container (non-stick coated)
- Large frying basket; can be raised or lowered with the lid closed
- Pop-up lid with viewing window, removable
- On/off switch (0-1)
- Adjustable thermostat with LED
- 130°C-190°C
- 2 control lamps for power and heating
- Changeable odour and fumes filter
- 2 recessed grips for safe transport
- Automatic cable rewind on the back
- 230 V, 50 Hz, 1800 W
- W x H x D approx. 280 x 275 x 320 mm

**Deep fat fryer**  
FR 3548

- Cool touch housing
- Capacity: 3 litre of oil/frying fat
- Removable oil container (non-stick coated)
- Large frying basket; can be raised or lowered with the lid closed
- Pop-up lid with viewing window
- Infinitely variable thermostat
- 130°C-190°C
- 30 minute timer with shut-off signal
- 2 control lamps for temperature/operation
- Changeable odour and fumes filter
- Cable rewind
- 230 V, 50 Hz, 2000 W
- W x H x D approx. 260 x 260 x 420 mm

**Stainless steel deep fat fryer**  
FR 3586

- Housing, lid, heating coil made of stainless steel
- Cool zone technology – heating coils immersed directly in the oil for rapid heating and for odorless frying
- Capacity: 3 litre of oil/frying fat
- Continuously adjustable thermostat with control lamp
- Removable fat container (enamelled)
- Stainless steel heating coil (removable)
- Drip tray
- Handles (thermally insulated)
- Cord storage
- Overheating protection
- 230 V, 50 Hz, 2000 W
- W x H x D approx. 215 x 240 x 405 mm

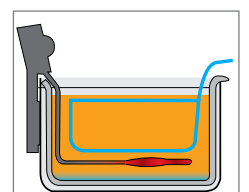

Art. no. 263 181  
EAN 4 006 160 631 814

PU 2



Art. no. 283 045  
EAN 4 006 160 830 453

PU 2



Art. no. 263 684  
EAN 4 006 160 636 840

PU 2





Stainless steel



Stainless steel

### Stainless steel deep fat fryer FR 3587

- Housing, lid, heating coil and grease trap made of stainless steel
  - Cool zone technology – heating coils immersed directly in the oil for rapid heating and for odorless frying
  - Capacity: 3 litre of oil/frying fat
  - Continuously adjustable thermostat with control lamp
  - Lid with viewing window
  - Stainless steel grease trap (removable)
  - Stainless steel heating coil (removable)
  - Drip tray
  - Handles (thermally insulated)
  - Changeable odour and fumes filter
  - Cord storage
  - Overheating protection
- 230 V, 50 Hz, 2000 W  
■ WxHxD approx. 215 x 240 x 405 mm



Stainless steel grease trap (removable)

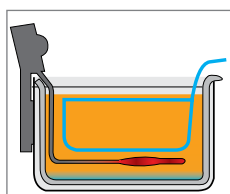

### Double deep fat fryer FR 3195

- Professional double deep fat fryer with 2 small baskets and one large frying basket for various types of food
  - Housing, lid, heating coil made of stainless steel
  - Cool-zone technology – heating element directly in the fat for rapid heating and low-odour deep fat frying
  - Capacity: 4 litre of oil/frying fat
  - Removable fat container (enameled)
  - Splash guard lid with filter
  - Continuously adjustable thermostat up to 190°C
  - 2 control lamps for power and heating
  - Overheating protection
- 230 V, 50 Hz, 2x2000 W  
■ WxHxD approx. 227 x 375 x 385 mm

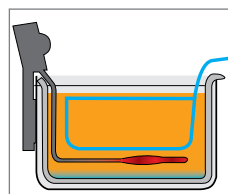

● Art. no. 263 685  
EAN 4 006 160 636 857 PU 2



● Art. no. 273 531  
EAN 4 006 160 735 314 PU 2







2in1

2in1

Stainless steel

**Rice cooker**  
RK 3566

**Rice cooker**  
RK 3567

- Rice cooker and steam cooker in one
  - Rice cooker for easy preparation and keeping warm all types of rice, pulses, soups, cereals
  - Additional aluminium steamer insert for vitaminretaining steam cooking of e.g. vegetables, potatoes and fish
  - Safety glass lid with steam outlet
  - Removable pot (non-stick coating)
  - For max. 1300 g of rice (uncooked weight) yields approximately 2500 g cooked rice
  - Automatic keep warm mode when cooking has finished
  - Automatic switch-off (energy-saving)
  - On/off switch
  - Cool touch handles
  - Removable supply cable
  - Safety function: can only be switched on when pot is in position
  - 3 control lamps for cooking, keeping warm and mains
  - Accessories: measuring beaker (160 ml max.), rice spoon
- 220–240 V, 50 Hz, 700 W  
■ W x H x D approx. 310 x 310 x 260 mm

- Rice cooker and steam cooker in one
  - Rice cooker for easy preparation and keeping warm all types of rice, pulses, soups, cereals
  - Stainless steel housing
  - Additional aluminium steamer insert for vitaminretaining steam cooking of e.g. vegetables, potatoes and fish
  - Safety glass lid with steam outlet
  - Removable pot (non-stick coating)
  - For max. 1300 g of rice (uncooked weight) yields approximately 2500 g cooked rice
  - Automatic keep warm mode when cooking has finished
  - Automatic switch-off (energy-saving)
  - On/off switch
  - Cool touch handles
  - Removable supply cable
  - Safety function: can only be switched on when pot is in position
  - 3 control lamps for cooking, keeping warm and mains
  - Accessories: measuring beaker (160 ml max.), rice spoon
- 220–240 V, 50 Hz, 700 W  
■ W x H x D approx. 310 x 310 x 260 mm



Incl. aluminium steamer insert



Incl. aluminium steamer insert



Art. no. 263 235  
EAN 4 006 160 632 354 PU 2

Art. no. 263 236  
EAN 4 006 160 632 361 PU 2



Jam/marmelade  
programWholemeal  
program

Stainless steel

Jam/marmelade  
programWholemeal  
program

### Bread maker

BBA 3505

- Fully automatic dough and bread preparation (kneading, rising, baking)
- Removable non-stick coated baking form
- 2 litre capacity (corresponds to about 1000 g bread)
- 12 baking programs / 39 available settings
- Programs: Normal, French, Whole Wheat, Fast Bake, Sweet, Ultra Fast Bake I, Ultra Fast Bake II, Dough, Jam, Cake, Sandwich, Bake
- Extra bake function
- Warming function
- Electronic control panel with backlight LCD display
- 13 hour timer
- Variably settable dough quantity
- Variable crust browning control (light, medium, dark)
- Cool touch housing
- Lid with viewing window (removable)
- 230 V, 50 Hz, 600 W
- W x H x D approx. 405 x 305 x 265 mm

### Bread maker

BBA 3365

- Fully automatic dough and bread preparation (kneading, rising, baking)
- Removable nonstick coated baking form
- 2 litre capacity (corresponds to about 1000 g bread)
- 11 baking programs / 34 possible combinations
- Programs: Normal, French, Whole Wheat, Fast Bake, Sweet, Dough, Jam, Cake, Sandwich, Bake, Knead
- Warming function
- Electronic control panel with LCD display and audible signal (blue illuminated)
- 13 hour timer
- Variably settable dough quantity
- Variable crust browning control (light, medium, dark)
- Lid with viewing window (removable)
- 230 V, 50 Hz, 700 W
- W x H x D approx. 360 x 305 x 255 mm



Electronic control panel with LCD-Display

Art. no. 261 690  
EAN 4 006 160 616 903

PU 2

Art. no. 263 159  
EAN 4 006 160 631 593

PU 2





2in1

Hot dog maker  
& egg boiler

**Steam cooker**  
DG 3235

- Steam cooker for the healthy cooking of food without burning vitamins
- 3 steam cooker containers (1 lid, 1 rise bowl)
- Semi-transparent water tank (1.6 litre)
- Drip bowl for the collection of juices
- 60 minute timer
- Water replenishable during operation
- Water level indicator
- Easy to clean
- Overheating protection
  
- 230 V, 50 Hz, 750 W max.
- W x H x D approx. 300 x 420 x 210 mm

**Steam cooker**  
DG 3547

- Steam cooker for the healthy cooking of food without burning vitamins
- Water-inflow-control – faster steam generation
- 3 steam cooker containers, 1 lid, 1 rise bowl
- High-grade steel base
- Programmable digital timer
- Incl. LCD display (blue illuminated)
- Incl. power control light
- Drip pan for collecting liquids
- Water level indicator
- Add more water during operation
- Easy to clean
- Overheating protection
  
- 220–240 V, 50/60 Hz, 700–800 W
- W x H x D approx. 310 x 445 x 240 mm

**Hot dog maker**  
HDM 3420 EK N

- Hot dog maker and egg boiler in one
- For 1 to 14 small sausages (e. g. "Frankfurter", "Vienna sausages")
- Heated stainless steel skewer
- Preparation of up to 6 eggs
- Removable egg holder
- Transparent steam tank (removable)
- Non-stick coated water bowl
- 2 separate switches for spike and steamer (blue illuminated)
- Incl. measuring cup with egg pricker
  
- 230 V, 50 Hz, 380 W
- W x H x D approx. 235 x 270 x 160 mm



High-grade steel base incl. LCD display / timer with backlight



Art. no. 251 109  
EAN 4 006 160 511 093

PU 4

Art. no. 283 044  
EAN 4 006 160 830 446

PU 2

Art. no. 251 136  
EAN 4 006 160 511 369

PU 6





Stainless steel

Stainless steel

Ceramic coated

180° opening

**Contact grill**  
KG 3487

**Contact grill**  
KG 3571

- Contact grill for double-sided, fat-free grilling
  - Fat drainage channel and drip tray (tray removable for easy cleaning)
  - 2000 watts
  - Stainless steel housing
  - Continuously adjustable thermostat
  - Short cooking times
  - Non-stick grill plates with extra deep grooves for strong grill pattern and smooth fat drainage
  - Large, heat-insulated handle
  - 2 control lamps for power supply and heating
  - Temperature "ready" display
  - Large grill area: approx. 29.5 x 23.5 cm
  - Cord storage
  - Versatile, can be used for e.g. panini, steaks, fish or vegetables
- 220–240 V, 50/60 Hz, 2000 W
- W x H x D approx. 335 x 145 x 330 mm

- Contact grill for double-sided, fat-free grilling
  - Barbecue grill – 180° opening enables grilling on a large surface
  - Fat drainage channel and drip tray (tray removable for easy cleaning)
  - 2000 watt
  - Stainless steel housing
  - Continuously adjustable thermostat
  - Short cooking times
  - Scratch-resistant, ceramic coated grill plates with extra deep grooves for strong grill pattern and optimal fat runoff
  - Large, heat-insulated handle
  - 2 control lamps for power supply and heating
  - Temperature "ready" display
  - Large grill areas: 2x approx. 29.5 x 23.5 cm
  - Cord storage
  - Versatile, can be used for e.g. panini, steaks, fish or vegetables
- 220–240 V, 50/60 Hz, 2000 W
- W x H x D approx. 356 x 145 x 336 mm



Stainless steel housing



Scratch resistant ceramic coating



Stainless steel housing



Barbecue grill – 180° opening enables grilling on a large surface

Stiftung Warentest

test

1

**GUT (2,4)**

Im Test:  
9 Kontaktgrills  
6 x gut  
2 x befriedigend  
1 x ausreichend

Ausgabe  
06/2015  
[www.test.de](http://www.test.de)  
15TZ20

● Art. no. 261 670  
EAN 4 006 160 616 705 PU 3



● Art. no. 263 657  
EAN 4 006 160 636 574 PU 3







**Teppanyaki grill**  
TYG 3608

**Party pan**  
PP 3401

- Japanese-style grilling at the table (healthy and low in calories)
  - Fat-free, odourless and clean
  - Ideal for roasting, cooking and braising fish, meat and vegetables
  - Continuously adjustable thermostat
  - Non-stick coated plate retains and distributes the heat perfectly (easy to clean)
  - Grill area: approx. 45 x 25 cm
  - Drainage channel for excess fat
  - Removable drip tray (easy-to-clean)
  - Heat-insulated carrying handles
  - Safe base
- 230 V, 50 Hz, 2000 W
- WxHxD approx. 542 x 127 x 247 mm

- Party pan for cooking, roasting, steaming, defrosting and with keep warm function
  - Quick heating and long keep warm function
  - Removable supply line with continuously adjustable thermostat
  - Anti-stick pan for easy cleaning
  - Ø 32 cm, depth: 3.5 cm
  - Heat-resistant glass lid with handle
  - Heat-insulated carrying handles
- 220–240 V, 50/60 Hz, 1500 W
- WxHxD approx. 380 x 160 x 400 mm



Removable drip tray (easy-to-clean)



Removable thermostat

● **Art. no. 263 706**  
EAN 4 006 160 637 069

PU 4



● **Art. no. 251 129**  
EAN 4 006 160 511 291

PU 4





Ceramic coated



**Party pan**  
PP 3401 C

- Party pan for cooking, roasting, steaming, defrosting and with keep warm function
- Quick heating and long keep warm function
- Removable supply line with continuously adjustable thermostat
- Ceramic coated pan (scratch-proof and easy to clean)
- Ø 32 cm, depth: 3.5 cm
- Heat-resistant glass lid with handle
- Heat-insulated carrying handle
  
- 220–240 V, 50/60 Hz, 1500 W
- W x H x D approx. 380 x 160 x 400 mm

**Party pan**  
PP 2914

- Party pan for cooking, roasting, steaming, defrosting and with keep warm function
- Quick heating and long keep warm function
- Removable supply line with continuously adjustable thermostat
- Non-stick coated pan (easy to clean)
- Ø 38 cm, depth: 4 cm
- Heat-resistant glass lid with handle
- Heat-insulated carrying handles
  
- 220–240 V, 50 Hz, 1400 W
- W x H x D approx. 450 x 140 x 400 mm



Scratch resistant ceramic coating

● **Art. no. 263 655**  
EAN 4 006 160 636 550 PU 2



● **Art. no. 251 102**  
EAN 4 006 160 511 024 PU 2





Ceramic coated



**Party pan**  
PP 3570 C

- Party pan for cooking, roasting, steaming, defrosting and with keep warm function
- Quick heating and long keep warm function
- Removable supply line with continuously adjustable thermostat
- Ceramic coated pan (scratch-proof and easy to clean)
- Ø 42 cm, depth: 9 cm
- Heat-resistant glass lid with handle
- Heat-insulated carrying handles
  
- 220–240 V, 50/60 Hz, 1500 W
- WxHxD approx. 430 x 145 x 490 mm

**Party pan**  
PP 3410

- Party pan for cooking, roasting, steaming, defrosting and with keep warm function
- Quick heating and long keep warm function
- Removable supply line with continuously adjustable thermostat
- Non-stick coated pan (easy to clean)
- Dimension: 30 x 30 cm, depth: 5 cm
- Heat-resistant glass lid with handle
- Heat-insulated carrying handles
  
- 220–240 V, 50/60 Hz, 1500 W
- WxHxD approx. 415 x 175 x 300 mm



Scratch resistant ceramic coating

● **Art. no. 263 656**  
EAN 4 006 160 636 567 PU 2



● **Art. no. 251 131**  
EAN 4 006 160 511 314 PU 4



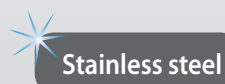

68

### Pizza/party pan PP 3402

- Pizza/party pan for boiling, frying, steaming, defrosting, keeping warm and making pizzas
- Quick heating and long keep warm function
- Removable supply line with continuously adjustable thermostat
- Non-stick coated pan (easy to clean)
- Ø 36 cm, depth: 3.5 cm
- Heat-resistant glass/metal lid with handle
- Heat-insulated carrying handles
- 220–240 V, 50/60 Hz, 1500 W
- W x H x D approx. 430 x 160 x 360 mm

### Fondue set FD 3516

- Stainless steel fondue pot, rustproof (Ø 18.5 cm)
- Filling capacity up to max. 1.2 litre
- Fondue pot with encapsulated sandwich base for better heat distribution – also usable individually on different hobs (gas, electric, glass ceramic, halogen)
- Separate, stable hotplate made of stainless steel
- Continuously adjustable thermostat (illuminated)
- Thermal cut-out
- Thermal fuse
- Stainless steel splash protection with fork holder (removable)
- Accessories: 8 stainless steel fondue forks, color-coded
- 220–240 V, 50/60 Hz, 1200–1400 W
- W x H x D approx. 285 x 180 x 185 mm



Continuously adjustable thermostat (illuminated)

● Art. no. 251 130  
EAN 4 006 160 511 307 PU 4



● Art. no. 261 704  
EAN 4 006 160 617 047 PU 4







### Raclette grill RG 3592

- 2 persons raclette
- Cool touch housing
- For grilling and baking
- Grill area: approx. 20.5 x 10.5 cm
- 2 pans
- Grill plate and pans with non-stick coating (easy to clean)
  
- 230 V, 50 Hz, 350 W
- WxHxD approx. 300 x 105 x 105 mm

### Raclette grill RG 3517

- Cool touch housing
- For grilling and browning
- Removable grill plate
- 8 pans
- 8 wooden spatulas
- Continuously adjustable thermostat
- Control lamp
- Non-stick coating on the grill plates and pans (easy to clean)
- Grill area: approx. 40.5 x 30 cm
- Safe base through rubberised feet
  
- 220–240 V, 50/60 Hz, 1200–1400 W
- WxHxD ca. 430 x 130 x 340 mm



8 wooden spatulas



## 2 in 1 Raclette grill RG 3518

- Cool touch housing
- For grilling and browning
- Turning iron plate – Combination grill area for grilling fish (smooth surface) or meat (extra deep grooves for an intense grill pattern)
- Natural grill stone for a healthy, low-fat grilling
- Total grill area: ca. 46 x 23 cm (2x ca. 23 x 23 cm)
- 8 pans, 8 wooden spatula
- Continuously adjustable thermostat (blue illuminated)
- Non-stick coating on the grill plates and pans (easy to clean)
- 220–240 V, 50/60 Hz, 1200–1400 W
- WxHxD approx. 465 x 150 x 235 mm

## Electric grill lighter EGA 3404

- Electric grill lighter for the safe ignition of grilling charcoal and charcoal briquettes
- No chemicals, no smells
- For clean, fast grilling enjoyment
- Minimum smoke level
- Barbecue fire ignited in about 10 minutes
- Simple operation
- Large ignition surface with 3 filaments
- Incl. depositing aid (wall installation possible)
- Heat-insulated handle (ergonomically designed)
- Easy to clean
- 220–240 V, 50/60 Hz, 800 W
- WxHxD approx. 200 x 75 x 510 mm



Natural grill stone for a healthy, low-fat grilling



Continuously adjustable thermostat (illuminated in blue)



Combination grill area for grilling fish or meat (turning iron plate)



Art. no. 261 706  
EAN 4 006 160 617 061

PU 2



Art. no. 271 676  
EAN 4 006 160 716 764

PU 6





2in1



2in1

**Barbecue standing grill**  
BQS 3508

**Barbecue standing grill**  
BQS 3591

- Stand grill in an attractive design with low smoke emission and low smell
- Continuously adjustable thermostat with control lamp
- Chromed grill grid
- Removable grill and heating elements for easy cleaning
- Cool touch housing
- Metal drip tray
- Wind protection (removable)
- Additional tray
- Can be converted to a table grill
- Grill height: approx. 80 cm
- Grilling surface: 35.5 x 24.5 cm
- 230 V, 50 Hz, 2000 W
- WxHxD approx. 515 x 855 x 390 mm

- Stand grill in an attractive design with low smoke emission and low smell
- Fat drainage channel and drip tray (tray removable for easy cleaning)
- Continuously adjustable thermostat with control lamp
- Grill plates with deep grooves for strong grill pattern and optimal fat drain (non-stick coated)
- Removable grill element for easy cleaning
- Stainless steel insert
- Cool touch housing
- Wind protection (removable)
- Can be converted to a table grill
- Grill height: approx. 76 cm
- Extra large grilling surface: approx. 50 x 25 cm
- 230 V, 50/60 Hz, 2200 W
- WxHxD approx. 545 x 845 x 385 mm



Can be converted to a table grill



Can be converted to a table grill

● **Art. no. 261 697**  
EAN 4 006 160 616 972 PU 4



● **Art. no. 263 693**  
EAN 4 006 160 636 932 PU 2





Grill rack and warming rack (enameled)



Convenient storage basket for different grilling utensils



## Gas grill GG 3590

- 2x heating zones for separate temperature control (2 Burner)
- Sturdy grill hood with integrated temperature display
- Control knobs for continuous temperature setting
- 48,5 x 37,5 cm grill area comprising of one enameled grill rack (dishwasher safe)
- 48,5 cm long warming rack (enameled)
- Removable grease collection tray for easy cleaning
- 2 x burners
- Housing and side trays made of powder-coated steel
- Two wheels for convenient movement
- Convenient storage basket for different grilling utensils
- Large storage room / Storage for gas bottle
- Including gas pressure reduction valve and gas tube for Germany and Austria

### Specifications

- Burners: 2
- Main burner: 2x 2,75 kW / 5,5 kW
- Gas consumption: 400 gr/h
- Operating pressure: 50 mbar
- Ignition: Piezo ignition system
- Gas category: 13B/P(50)
- Gas type: Butane, propane, or their mixtures
- Target destinations: D, A, CH
- CE certification: Intertek institute, certification number: 0359BU1034
- W x H x D approx. 970 x 1000 x 550 mm



Integrated temperature display





### Barbecue table grill BQ 2977 N

- Table grill in an attractive design without fire and smoke
- Cool touch housing
- On/off switch with indicator lamp
- Removable grill and heating elements for easy cleaning
- Metal drip tray
- Grilling surface: 35.5 x 24.5 cm
- 230 V, 50 Hz, 2000 W
- WxHxD approx. 480 x 100 x 360 mm

### Barbecue table grill BQ 3507

- Table grill in an attractive design with low smoke emission and low smell
- Continuously adjustable thermostat with control lamp
- Chromed grill grid
- Removable grill and heating elements for easy cleaning
- Cool touch housing
- Metal drip tray
- Wind protection
- Grilling surface: 36 x 25 cm
- 230 V, 50 Hz, 2000 W
- WxHxD approx. 515 x 95 x 375 mm



74

### Barbecue table grill BQ 3443

- Table grill in an attractive design without fire and smoke
- Also suitable for outdoor use
- Continuously adjustable thermostat with control lamp
- Height-adjustable, chromed grill grid
- Removable grill and heating elements for easy cleaning
- Enameled housing
- Enameled steel tub
- Metal drip tray
- Grilling surface: 40 x 22,5 cm
- 230 V, 50 Hz, 2000 W
- W x H x D approx. 530 x 100 x 310 mm

### Convection oven HLO 3523

- Gentle cooking by circulating hot air, low-fat and vitamin-preserving
- Many different uses for baking, roasting, grilling, steaming, braising, defrosting, heating, barbecuing (easy to use)
- Halogen heating element for faster heating
- Saves time and energy: requires up to 45 % less energy than a conventional oven
- Ideal for small kitchens and mobile use
- Continuously adjustable thermostat from 0–200 °C
- 12 litre interior
- Glass bowl: Ø 33 cm
- Container made of safety glass – heat and scratch-resistant (dishwasher-safe)
- 60 minute timer with alarm when cooking is completed
- Control lamps for operation and temperature
- Safety switch, practical safety handle
- Heat-insulated carrying handles
- Accessories: upper and lower grid, steamer insert, tongs, skewers, lid holder
- 220–240 V, 50/60 Hz, 1200–1400 W
- W x H x D approx. 380 x 335 x 355 mm



Lower/upper grid



Steamer insert

● Art. no. 263 208  
EAN 4 006 160 632 088 PU 4



● Art. no. 263 234  
EAN 4 006 160 632 347 PU 1





**NEW!** Pizza maker  
PM 3622

- 1800 Watt
- Continuously adjustable thermostat
- Short cooking times
- Non-stick baking plates
- Large, heat-insulated handle
- 2 control lamps for power supply and heating
- Temperature "ready" display
- Large baking surface: approx. Ø 28 cm
- Cord storage
- On/Off switch
  
- 220–240 V, 50/60 Hz, 1800 W
- WxHxD approx. 315 x 160 x 375 mm

Mini oven  
MB 3463

- 8 litre capacity
- Top and bottom heat
- 15 minute timer
- 2 quartz heating elements
- Pull-out grill grid
- Baking tray
- Drawer for crumbs
- Overheating protection
  
- 220–240 V, 50/60 Hz, 800 W
- WxHxD approx. 365 x 220 x 250 mm





76

### Multi pizza oven MPO 3520

- Pizza oven ideal for grilling and crisping up
- Large grill, ideal for pizza (26 x 25 cm)
- Including baking tray (23.5 x 22 cm)
- Capacity: approx. 12 litre
- Top and bottom heat (combined operation possible)
- 4-step switch (top heat, bottom heat, top and bottom heat combined, off)
- 2 quartz heating elements
- 60 minute timer with end signal
- Stainless steel handle
- Crumb tray
- Overheating protection
- 220–240 V, 50/60 Hz, 1000 W
- WxHxD approx. 375 x 220 x 330 mm

### Multi oven MBG 3521

- 28 litre capacity
- Circulating air
- Top and bottom heat, combined operation
- Revolving spit
- 60 minute timer with end signal
- 5 level switch (top/bottom/top and bottom heat/revolving spit/off)
- Variable temperature control (100°C–230°C)
- Control lamp
- Includes grill grid, baking tray, revolving spit
- Includes tongs for removing the grill grid and baking tray, tool for removing the revolving spit
- Large viewing window
- 220–240 V, 50/60 Hz, 1500 W
- WxHxD approx. 520 x 335 x 420 mm



Incl. baking tray (23.5 x 22 cm)

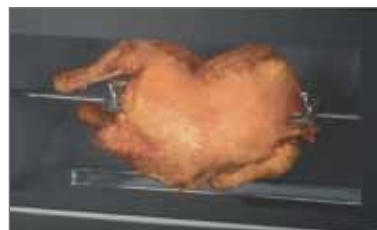

Incl. revolving spit

● Art. no. 261 708  
EAN 4 006 160 617 085 PU 4



● Art. no. 261 710  
EAN 4 006 160 617 108 PU 1







**NEW!** Multi oven  
MBG 3621

Mini kitchen  
KK 3522

- 28 litre capacity
- Circulating air
- Top and bottom heat, combined operation
- Revolving spit
- 60 minute timer with end signal
- 6 level switch
  - Top and bottom heat
  - Top and bottom heat + circulating air
  - Top heat + circulating air
  - Top heat + revolving spit
  - Top and bottom heat + revolving spit + circulating air
  - Off
- Variable temperature control (100°C–230°C)
- Control lamp
- Includes grill grid, baking tray, revolving spit
- Includes tongs for removing the grill grid and baking tray, tool for removing the revolving spit
- Large viewing window
- 220–240 V, 50/60 Hz, 1500 W
- W x H x D approx. 495 x 380 x 330 mm

- 2 hotplates
  - 1x Ø 18.5 cm, 1500 watt
  - 1x Ø 15.5 cm, 1000 watt
- 2 different operating controls for the hotplates:
  - Small – rotary switch level 0–4
  - Large – rotary switch level 0, 850, 1100 and 1500 watt
- 28 litre capacity
- Combined operation (baking and cooking at the same time)
- Top and bottom heat (900/600 watt)
- Possible baking/grilling alternatives:
  - Top and bottom heat
  - Only bottom heat
  - Top heat
- Infinitely adjustable thermostat
- Control lamp
- Oven door with viewing window
- Including grill grating, baking sheet, and crumbs drawer, as well as hookable handle for pulling out the sheet/grating
- Power supply:
  - 600 watt oven (bottom heat), 900 watt oven (top heat)
  - 1000 watt hotplate (small), 1500 watt hotplate (large)
  - 3400 watt (total power consumption)
- 220–240 V, 50 Hz, 3400 W
- W x H x D approx. 515 x 360 x 390 mm



Incl. revolving spit

● Art. no. 263 719  
EAN 4 006 160 637 199 PU 1



● Art. no. 261 709  
EAN 4 006 160 617 092 PU 1





2in1



ELECTRONIC

78

### Microwave MW 785

- 700 watt microwave
- 20 litre oven capacity
- 5 level
- Rotating plate, Ø approx. 24.5 cm
- 30 minute timer with end signal
- Oven light
- Large viewing window
- 230 V, 50 Hz, 1200 W
- WxHxD approx. 455 x 265 x 340 mm

- **Art. no. 253 139**  
EAN 4 006 160 531 398 PU 1
- **Art. no. 263 717**  
EAN 4 006 160 637 175 PU 1
- **Art. no. 253 140**  
EAN 4 006 160 531 404 PU 1

2in1

### Microwave with grill MWG 786

#### Features such as 785 MW + Grill

- 900 watt grill
- 5 microwave power level
- 3 level in combined operation grill/microwave
- 1 grill level
- Cooking grid: Ø approx. 21.0 cm
- 230 V, 50 Hz, 1200 W
- WxHxD approx. 455 x 265 x 340 mm

- **Art. no. 253 141**  
EAN 4 006 160 531 411 PU 1
- **Art. no. 253 145**  
EAN 4 006 160 531 459 PU 1
- **Art. no. 253 146**  
EAN 4 006 160 531 466 PU 1



### Microwave with grill MWG 787

- 700 watt microwave
  - 900 watt grill
  - 20 litre capacity
  - 6 microwave power level
  - 2 level in combined operation grill/microwave
  - 1 grill level
  - 9 automatic programs incl. defrost program
  - Express program
  - Rotating plate: Ø approx. 24.5 cm
  - Cooking grill: Ø approx. 21.0 cm
  - 60 minute timer with end signal
  - Easy Tronic
  - Digital clock
  - Child lock
  - Oven light
  - Large viewing window
- 230 V, 50 Hz, 1200 W
  - WxHxD approx. 455 x 265 x 335 mm

- **Art. no. 253 143**  
EAN 4 006 160 531 435 PU 1





2in1



Stainless steel

**Microwave with grill**  
MWG 783 E

- Stainless steel housing
- 700 watt microwave
- 1000 watt grill
- 20 litre capacity
- 5 microwave power level
- 3 level in combined operation microwave/grill
- 1 grill level
- Rotating plate, Ø approx. 25.5 cm
- Grilling grid, Ø approx. 21.0 cm
- 35 minute timer with end signal
- Oven light
- Large viewing window
- 230 V, 50 Hz, 1050 W
- WxHxD approx. 435 x 255 x 355 mm



3in1

Convection



Stainless steel

**Microwave with grill and convection**  
MWG 788 H

- Stainless steel front
- 800 watt microwave power
- 1350 watt grill
- 1350 watt convection
- Quick-start function
- 20 litre capacity
- 11 microwave power level
- 2 level in combined operation (grill/microwave)
- 4 level in combined operation (convection/microwave)
- 1 grill level
- 10 temperature settings for convection
- 9 automatic programs incl. defrost program
- Rotating plate, Ø approx. 24.5 cm
- Grilling grid, Ø approx. 21.0 cm
- 95 minute timer with end signal
- Quartz heating elements
- Digital clock
- Child lock
- Oven light
- 230 V, 50 Hz, 1350 W
- WxHxD approx. 455 x 262 x 375 mm

**4in1**

Convection

Pizza function

**3in1**

Convection

### Microwave with grill and convection MWG 789 H

- 800 watt microwave power
  - 1200 watt grill
  - 1200 watt convection
  - 23 litre capacity
  - 5 microwave power level
  - 4 level in combined operation (grill/microwave)
  - 1 grill level
  - 10 temperature settings for convection
  - 10 automatic programs
  - Defrost program
  - Quick-start program
  - Incl. pizza program and pizza plate, Ø approx. 28.0 cm
  - Rotating plate, Ø approx. 27.0 cm
  - Grilling grid, Ø approx. 21.0 cm
  - 95 minute timer with end signal
  - Quartz heating elements
  - Digital clock
  - Child lock
  - Oven light
- 230 V, 50 Hz, 1300 W
  - WxHxD approx. 490 x 295 x 410 mm

### Microwave with grill and convection MWG 775 H

- Stainless steel housing
  - Reflecting glass front
  - 800 watt microwave
  - 1200 watt grill
  - 1200 watt convection
  - 23 litre capacity
  - 4 microwave power level
  - 3 level in combined operation (microwave/grill)
  - 10 level in combined operation (microwave/convection)
  - 1 grill level
  - 10 temperature settings for convection
  - 9 automatic programs
  - Defrost program
  - Rotating plate, Ø approx. 27.0 cm
  - Grilling grid, Ø approx. 22.0 cm
  - 95 minute timer with end signal
  - Quartz heating elements
  - Digital clock
  - Child lock
  - Oven light
- 230 V, 50 Hz, 1300 W
  - WxHxD approx. 485 x 295 x 405 mm



Pizza function incl. pizza plate

Pizza plate with active, heat-storing special coating for extra crispy and crunchy pizza crusts.

The pizza plate is preheated via the microwave function and then baking of the pizza is completed in combination operation.

Ideal for deep-frozen pizza and freshly prepared pizza crusts.

● Art. no. 253 147  
EAN 4 006 160 531 473 PU 1



● Art. no. 253 126  
EAN 4 006 160 531 268 PU 1







4in1

Convection

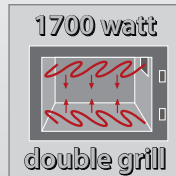

Stand-alone/  
Under-cabinet mounting

**Double-grill microwave**  
MWG 779 H

**Combined microwave oven with grill**  
MWG 777 U

- Stainless steel housing
- Stainless steel interior
- Double grill for, for example, crispy pizza, baguettes, soufflés, etc. (1200 watt top heat, 500 watt lower heat)
- 900 watt microwave
- 1700 watt double grill
- 2300 watt convection
- Quartz top heating element
- 25 litre capacity
- 5 microwave power level
- 10 temperature settings convection
- 10 automatic programs
- Defrost program
- Quick-start program
- Incl. pizza program and pizza stone, Ø approx. 30.0 cm
- Incl. enameled rotating platea, dishwasher-safe and scratchproof, Ø approx. 31.5 cm
- Grilling grid, Ø approx. 25.0 cm
- 95 minute timer with end signal
- Start delay
- Digital clock
- Child lock
- Oven light

- 230 V, 50 Hz, 1450 W
- W x H x D approx. 510 x 300 x 430 mm



Pizza function incl. pizza stone

- 800 watt microwave
- 1000 watt grill
- 20 litre capacity
- 5 microwave power level
- 3 level in combined operation
- 1 grill level
- Rotating plate, Ø approx. 24.5 cm
- Grilling grid, Ø approx. 21.0 cm
- 30 minute timer with end signal
- Oven light
- Large viewing window
- Can be positioned as required or used as a built-under appliance (Incl. installation material)
- 230 V, 50 Hz, 1250 W
- W x H x D approx. 461 x 365 x 280 mm



Built-under appliance

Art. no. 253 131  
EAN 4 006 160 531 312

PU 1



Art. no. 253 129  
EAN 4 006 160 531 299

PU 1





**Stand-alone/  
Under-cabinet mounting**



**Combined microwave oven with grill  
MWG 778 U**

**Built-in microwave with grill  
MWG 2215 EB**

- Stainless steel front
- 800 watt microwave
- 1000 watt grill
- 20 litre capacity
- 5 microwave power level
- 2 level in combined operation
- 1 grill level
- 8 automatic programs
- Defrost programs, selectable according to time and weight
- Quick-start program
- Rotating plate, Ø approx. 24.5 cm
- Grilling grid, Ø approx. 21.0 cm
- 95 minute timer with end signal
- Easy Tronic, digital clock, child lock
- Oven light
- Large viewing window
- Can be positioned as required or used as a built-under appliance (incl. installation material)
- 230 V, 50 Hz, 1250 W
- WxHxD approx. 460 x 285 x 370 mm

- Built-in microwave with frame
- Stainless steel front, stainless steel interior
- 800 watt microwave
- 1000 watt grill
- 5 microwave power level
- 2 level in combined operation (grill/microwave)
- 1 grill level
- 8 automatic programs
- Defrost programs, selectable according to time and weight
- 20 litre capacity
- Rotating plate, Ø approx. 24.5 cm, grilling grid, Ø approx. 21 cm
- 95 minute timer with end signal
- Start delay
- Child lock
- Oven light



Built-under appliance

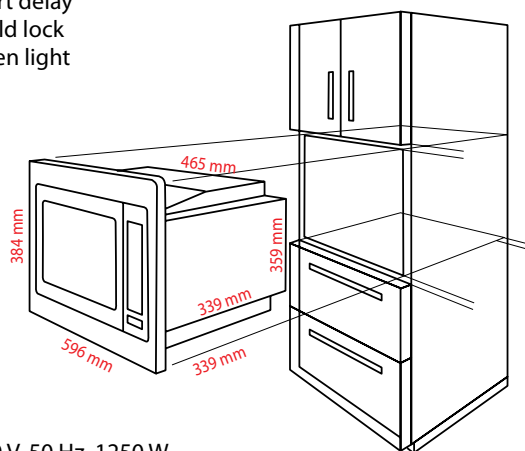

- 230 V, 50 Hz, 1250 W
- Appliance (WxHxD): 465 x 359 x 339 mm
- Appliance with frame (WxHxD): 596 x 384 x 339 mm
- Weight: approx. 14 kg

● Art. no. 253 130  
EAN 4 006 160 531 305 PU 1



● Art. no. 622 151  
EAN 4 004 470 221 510 PU 1





**Built-in microwave with grill and convection**  
MWG 2216 H EB

**Built-in microwave with grill and convection**  
MWG 2265 H EB

- Built-in microwave with frame
- Stainless steel front, stainless steel interior
- 900 watt microwave
- 1100 watt grill
- 2500 watt convection function
- 5 microwave power level
- 2 level in combined operation (grill/microwave)
- 2 level in combined operation (convection/microwave)
- 1 grill level
- 10 temperature settings for convection (130°C–220°C)
- 10 automatic programs
- Defrost program, quick-start program
- 25 litre capacity
- Rotating plate, Ø approx. 31,5 cm, grilling grid, Ø approx. 27,5 cm
- 95 minute timer with end signal
- Start delay
- Child lock
- Oven light

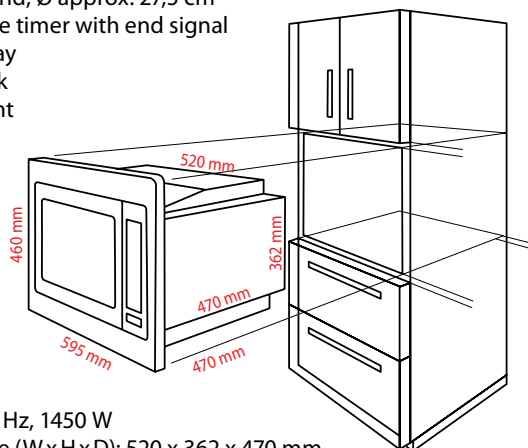

- 230 V, 50 Hz, 1450 W
- Appliance (W x H x D): 520 x 362 x 470 mm
- Appliance with frame (W x H x D): 595 x 460 x 470 mm
- Weight: approx. 21 kg

- Built-in microwave oven in frameless design
- Stainless steel front/interior
- Multi-function display (black/white)
- Control knob (illuminated)
- 900 watt microwave
- 1100 watt grill
- 2500 watt convection
- 5 microwave power levels
- 4 levels in combined operation (microwave/grill/convection)
- 1 grill level
- 10 temperature settings for convection (130°C–220°C)
- 10 automatic programs
- Defrost program, quick-start program
- 25 litre capacity
- Rotating plate, Ø approx. 31.5 cm, Grilling grid, Ø approx. 27.5 cm
- 95 minute timer with end signal
- Child lock
- Oven light

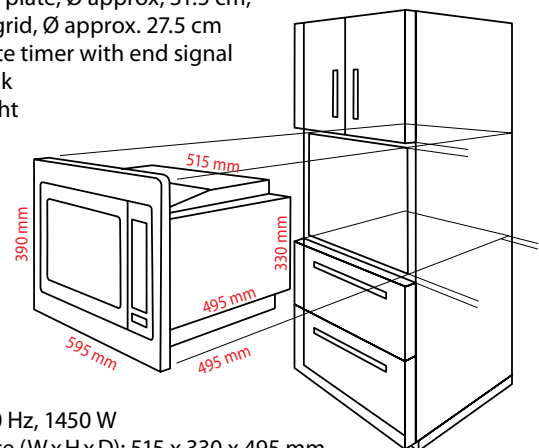

- 230 V, 50 Hz, 1450 W
- Appliance (W x H x D): 515 x 330 x 495 mm
- Appliance with frame (W x H x D): 595 x 390 x 495 mm
- Weight: approx. 21 kg



84

**NEW!** Alcohol tester  
AT 3605

- Alcohol tester in an attractive design
- Measurement standby function
- 2 digital LCD displays
  - Display in parts per thousand and g/l from 0.0 to 1.9 ‰ (red illuminated)
  - Temperature display in °C and °F
  - Time display (12/24 h)
- Optical warning at 0,2 ‰ and 0,5 ‰
- Countdown function (measuring readiness)
- Alarm function
- Automatic switch-off, prolongs battery life
- Low weight
- Battery operation: 2x AAA (batteries not included)

Preserving boiler  
EKA 3338

- 1800 watt
- 25 litre tank capacity for up to 14 jars
- Enameled housing, scratch-resistant
- Closed pot bottom, concealed stainless steel heating element
- Variable temperatur control (30–100 °C)
- Control lamp
- Integrated drain tap for practical filling of mulled wine, punch or other hot drinks, for example
- Hard-wearing enamel, tasteless
- Grid insert
- Plastic handles, heat-insulated
- Overheating protection
- 230 V, 50 Hz, 1800 W
- W x H x D approx. 455 x 495 x 435 mm

Single hotplate  
EKP 3582

- Hotplate, Ø approx. 180 mm, 1500 watt
- Infinitely adjustable thermostat
- Control lamp
- Heat-resistant finish
- High stability
- 230 V, 50 Hz, 1500 W
- W x H x D approx. 360 x 70 x 285 mm



2 digital LCD displays for:

- Time, temperature
- Alcohol content (red illuminated)

● Art. no. 271 704  
EAN 4 006 160 717 044

PU 12



● Art. no. 263 135  
EAN 4 006 160 631 357

VE 1



● Art. no. 271 698  
EAN 4 006 160 716 986

PU 4







### Double hotplate DKP 3583

- 2 hotplates
  - 1 x Ø approx. 180 mm, 1500 watt
  - 1 x Ø approx. 150 mm, 1000 watt
- 2 continuously variable thermostats
- 2 control lamps
- Heat-resistant finish
- High stability
  
- 230 V, 50 Hz, 2500 W
- W x H x D approx. 570 x 70 x 285 mm

### Single induction hotplate EKI 3569

- Induction hotplate with high-quality, eco-friendly glass-ceramic-surface
- Heating only takes seconds thanks to induction technology
- Scratch-resistant smooth cooking area (very easy to clean)
- ECO-Save – 55% time savings compared to conventional cooking plates, no preheating phase, energy saving
- Automatic pot detection – automatic switch-off in the case of non-induction pots
- 10 power level and 10 temperature level with LED indication (60° C–240° C)
- Electronic sensor touch control panel with display for comfortable operation
- 3 LED control lamps
- 180 minute timer with automatic switch-off and end signal
- Countdown indication
- Automatic switch-off after 120 min. without operation
- Automatic switch-off after removal of the pot
- Child lock
- High stability through non-slip feet
  
- 220–240 V, 50/60 Hz, 2000 W
- W x H x D approx. 290 x 65 x 370 mm



2in1

### Double induction hotplate DKI 3609

- Induction double hotplate with high-quality, eco-friendly glass-ceramic-surface
  - Heating only takes seconds thanks to induction technology
  - Scratch-resistant smooth cooking area (very easy to clean)
  - ECO-Save – 55% time savings compared to conventional cooking plates, no preheating phase, energy saving
  - Automatic pot detection – automatic switch-off in the case of non-induction pots
  - LED display
  - Each hob with 16 function levels – 6 power levels and 10 temperature levels (60 °C–240 °C)
  - Electronic Sensor Touch control panel with display for comfortable operation
  - 2x 3 LED indicator lights
  - 180 minute timer with automatic switch-off and end signal
  - Countdown indication on the LED display
  - Automatic switch-off after 120 min. without operation
  - Automatic switch-off after removal of the pot
  - High stability through non-slip feet
- 220–240 V, 50/60 Hz, 3500 W max.
  - WxHxD approx. 600 x 75 x 355 mm

### Travelling steam iron/steam brush DB 3108 B

- Variable temperature control, suitable for all types of fabric
  - Open turning handle
  - Control lamp
  - Non-stick-coated sole plate
  - Combined attachment: fluff removal and brushes
  - Vertical steam function for smoothing hanging textiles
  - Transparent water container (approx. 30 ml)
- 230 V, 50 Hz, 800 W
  - WxHxD approx. 185 x 226 x 128 mm



● Art. no. 263 703  
EAN 4 006 160 637 038 PU 2



● Art. no. 263 531  
EAN 4 006 160 635 317 PU 12





**Steam iron**  
DB 3578

- Special stainless steel sole plate
  - Steam jet function, spray device and vertical steam
  - Variable temperature control
  - Continuous steam regulation
  - Dry function (steam can be switched off)
  - Practical self-cleaning function
  - Transparent water container (approx. 135 ml)
  - Cable attached via 360° turnable joint
  - Indicator light
- 220–240 V, 50/60 Hz, 1700 W  
■ WxHxD approx. 110 x 140 x 260 mm

**Steam iron**  
DB 3105

- Special stainless steel sole plate
  - Steam jet function, spray device and vertical steam
  - Variable temperature control
  - 3-level steam control
  - Dry function (steam can be switched off)
  - Practical self-cleaning function
  - Transparent water container (approx. 130 ml)
  - Cable attached via 360° turnable joint
  - Indicator light
- 230 V, 50 Hz, 2000 W  
■ WxHxD approx. 115 x 155 x 275 mm

**Steam iron**  
DB 3475

- Special stainless steel sole plate
  - Steam jet function, spray device and vertical steam
  - Variable temperature control
  - Continuous steam regulation
  - Dry function (steam can be switched off)
  - Practical self-cleaning function
  - Transparent water container (approx. 200 ml)
  - Cable attached via 360° turnable joint
  - Indicator light
- 220–240 V, 50/60 Hz, 2200 W  
■ WxHxD approx. 110 x 150 x 275 mm



Ceramic

88

### Steam iron DB 3106

- Special stainless steel sole plate
- Steam jet function, spray device and vertical steam
- Variable temperature control
- Steam control
- Dry function (steam can be switched off)
- Anti-calc system
- Anti-drip function
- Practical self-cleaning function
- Transparent water container (approx. 200 ml)
- Open, rubberised handle
- Cable attached via 360° turnable joint
- Indicator light
- 220–240 V, 50/60 Hz, 2500 W
- WxHxD approx. 124 x 144 x 280 mm

### Steam iron DB 3512

- Special stainless steel sole plate
- 7 functions:
  - Spray device
  - Steam jet function
  - Vertical steam
  - Dry function (steam can be switched off)
  - Self-cleaning function (switchable)
  - Anti-drip function
  - Anti-calc system
- Variable temperature control
- Continuous steam regulation
- Transparent water container (approx. 360 ml)
- Cable attached via 360° turnable joint
- Indicator light
- 220–240 V, 50/60 Hz, 2500 W
- WxHxD approx. 115 x 150 x 290 mm

### Steam iron DB 3485

- Scratch-resistant ceramic sole plate with outstanding sliding behaviour
- 5 functions:
  - Spray device
  - Steam jet function
  - Vertical steam
  - Dry function (steam can be switched off)
  - Self-cleaning function (switchable)
- Variable temperature control
- Continuous steam regulation
- Transparent water container (approx. 250 ml)
- Cable attached via 360° turnable joint
- Indicator light
- Measuring cup
- 220–240 V, 50/60 Hz, 1800–2200 W
- WxHxD approx. 118 x 134 x 280mm



Easy-running, scratch-resistant ceramic sole plate

● Art. no. 263 529  
EAN 4 006 160 635 294 PU 6



● Art. no. 261 700  
EAN 4 006 160 617 009 PU 6



● Art. no. 261 668  
EAN 4 006 160 616 682 PU 6







Ceramic

**Steam iron**  
DB 3329

- Scratch-resistant ceramic sole plate with outstanding sliding behaviour
  - Steam jet function, spray device and vertical steam
  - Variable temperature control
  - Continuous steam regulation
  - Dry function (steam can be switched off)
  - Anti-calc filter system
  - Anti-drip function
  - Self-cleaning function (switchable)
  - Transparent water container (approx. 320 ml)
  - Rubberised handle for non-slip handling
  - Rubberised rest for excellent stability
  - Cable attached via 360° turnable joint
  - Indicator light
- 220–240 V, 50/60 Hz, 2500 W  
■ W x H x D approx. 125 x 155 x 310 mm



Ceramic

**Steam iron**  
DB 3486

- Scratch-resistant ceramic sole plate with outstanding sliding behaviour
  - 7 functions:
    - Spray device
    - Steam jet function
    - Vertical steam
    - Dry function (steam can be switched off)
    - Self-cleaning function (switchable)
    - Anti-drip function
    - Anti-calc filter system
  - Variable temperature control
  - 4-level steam control (0-1-2-3)
  - Transparent water container (approx. 360 ml)
  - Rubberised handle for non-slip handling
  - Rubberised rest for excellent stability
  - Cable attached via 360° turnable joint
  - Indicator light
- 220–240 V, 50/60 Hz, 2400–2800 W  
■ W x H x D approx. 120 x 160 x 300 mm



Easy-running, scratch-resistant ceramic sole plate





**2in1**

Also cordless useable

Ceramic



Incl. 2 anti-scale cartridges

Ceramic

**Steam iron**  
DBC 3388

- Scratch-resistant ceramic sole plate with outstanding sliding behaviour
- Steam iron, cordless
- 10 different functions: used without a cord, dry ironing (steam can be switched off), steam ironing, steam jet, vertical steam, 3-level steam setting, spray function, anti-calc filter system, anti-drip function, practical self-cleaning function
- Variable temperature control
- Transparent water container (approx. 220 ml)
- Incl. table attachment for stability and one-handed operation
- Rubberised handle for non-slip handling
- Indicator light
- 220–240 V, 50 Hz, 2000 W
- WxHxD approx. 290 x 245 x 130 mm

**Steam ironing unit**  
DBS 3611

- Scratch-resistant ceramic sole plate with outstanding sliding behaviour
- Constantly high heat resistance and optimal steam generation
- Even and consistent heat distribution through 20 steam nozzles
- With steam jet function (horizontal and vertical)
- Constant high steam output: max. 80 g/min.
- Removable water tank (2.3 litre capacity), in case of average operation sufficient for approx. 90 minutes
- Permanent refill function – refilling of the water tank during the operation possible
- Continuously adjustable temperature control
- 2 anti-scale cartridges
- Extra large rest plate to provide the iron with a stable rest
- Arrestable holding device
- Long connection cable
- Cable take-up on the base
- 230 V, 50/60 Hz, 2200 W max.
- WxHxD approx. 205 x 315 x 365 mm



Easy-running, scratch-resistant ceramic sole plate



Scratch resistant and smooth running ceramic sole plate



Removable water tank (2.3 litre capacity)



Replacement cartridge for DBS 3611

Art. no. 8 936 110  
EAN 4 006 160 632 606

● Art. no. 263 172  
EAN 4 006 160 631 722 PU 4



● Art. no. 263 708  
EAN 4 006 160 637 083 PU 2  
● Art. no. 263 707  
EAN 4 006 160 637 076 PU 2





### Mini-washing machine MWA 3540

- Light mini-washing machine
- Obviates the need for tedious hand washing at home and when travelling
- Ideal for both small washes and for sensitive laundry items
- Washes quickly and effectively with a consistent result
- Low water, electricity and detergent consumption
- Ideally suited for camping, holidays and single households
- 15 minute timer
- Incl. drainage hose and water inlet
- Capacity: 13 litre max. / 1.5 kg
  
- 230 V, 50 Hz, 135 W
- WxHxD approx. 330 x 460 x 360 mm



15 minute timer



Incl. water inlet and drainage hose



Water level indicator

### Fabric steamer TDC 3527

- Steamer for steam ironing, removes wrinkles and lint
- Gentle and effective method for removing creases from fabrics
- The gentle steam effect extends the lifespan of your clothes
- Saves time over traditional ironing
- Also suitable for sensitive materials
- Vertical steam function
- Quick warm-up time through 1500 watt of power – ready to use in around 45 seconds.
- Water tank with 1 litre capacity
- Use for up to 35 min on a full tank
- Ergonomically shaped handle with high-quality stainless steel insert
- 9 steam nozzles for quick and gentle smoothing of textiles
- Constant steam output: around 25 g/min
- Vertical steam ironing for hanging clothes, curtains etc.
- Anti-drip system
- Incl. practical carrying handle for mobile use
- Extra large operating radius with the approx. 1.5 m long hose and approx. 1.8 m cable length
- On/off switch (illuminated)
- Overheating protection
- Accessories: Fabric brush attachment for removing wrinkles and lint, crease attachment
  
- 220–240 V, 50/60 Hz, 1370–1630 W
- WxHxD approx. 300 x 200 x 195 mm



1 litre capacity water tank



Detachable 1.2 litre capacity water tank



Vertical steam ironing for hanging clothes



Gentle and effective method for removing creases from fabrics

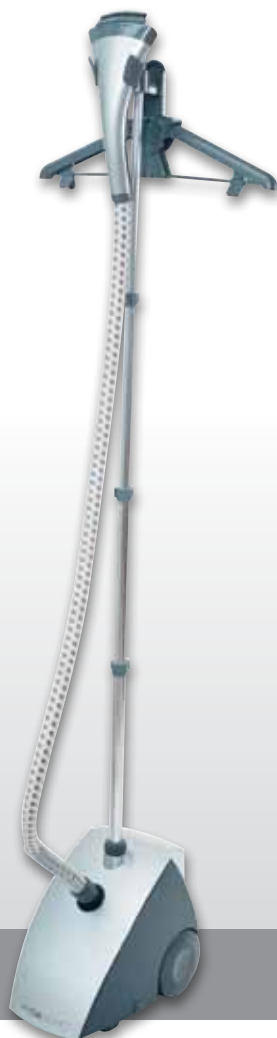

**Fabric steamer**  
TDC 3432



**Steam cleaner**  
DR 2930

- Steamer for steam ironing, removes wrinkles and lint
- Gentle and effective method for removing creases from fabrics
- The gentle steam effect extends the lifespan of your clothes
- Saves time over traditional ironing
- Also suitable for sensitive materials
- Vertical steam function
- Quick warm-up time through 1500 watt of power – ready to use in around 50 seconds
- Detachable 1.2 litre capacity water tank
- Use for up to 40 mins on a full tank
- Steplessly height-adjustable telescopic pole (to 1.35 m) for individual adjustment to body height and for easy storage
- Constant steam output: around 30 g/min.
- Vertical steam ironing for hanging clothes, curtains etc.
- Anti-drip system
- Easy to transport – through 2 large rollers and 2 360° casters
- Accessories: Trousers and clothes hanger, brush head, fabric brush attachment for removing wrinkles and bobbles
- On/off switch (illuminated)
- Overheating protection
- Fire protection fuse
- Cable length approx. 1.80 m
- 230 V, 50 Hz, 1500 W
- BxHxD ca. 340 x 1640 x 230 mm

- Steam cleaner, cleans, disinfects and degreases at 100°C without lime residues and cleaning strip
- 3.5 bar steam pressure
- Approx. 220 ml water tank
- Long lead, approx. 5 m
- Overpressure protection
- Overheating protection
- Incl. 8 accessories: Brush, nozzle, angle, fleece and window-cleaning attachments, hose, measuring beaker
- 220–240 V, 50/60 Hz, 1000 W
- W x H x D approx. 210 x 320 x 160 mm



8 accessories

Art. no. 263 561  
EAN 4 006 160 635 614 PU 1



Art. no. 283 009  
EAN 4 006 160 830 095 PU 2







**Steam cleaner**  
DR 3535

**Steam cleaner**  
DR 3536

- Steam cleaner, cleans, disinfects and degreases without limescale residues or streaks left behind from cleaning
- 3.5 bar steam pressure
- Approx. 300 ml water tank
- Long lead, approx. 5 m
- Overpressure protection
- Overheating protection
- Includes 9 accessories: 2x brush, nozzle, angle, fleece and windowcleaning attachments, hose, measuring beaker
- 220-240 V, 50/60 Hz, 1000 W
- WxHxD approx. 210 x 320 x 160 mm

- Steam cleaner, cleans, disinfects and degreases without limescale residues or streaks left behind from cleaning
- 3.5 bar steam pressure
- Approx. 600 ml water tank
- Aluminum boiler
- Control lamp (mains and standby)
- Safety tank lid with pressure relief valve
- Overheating protection
- On/off switch protected against water spray
- Practical carrying handle
- Smooth-running wheels
- Steam control on the handle
- Incl. 9 accessories: 2-part extendable insertable tube, floor brush, non-woven cloth, window wiper, jet nozzle attachments, round brush attachment, funnel, measuring beaker

- 230 V, 50/60 Hz, 1350 W
- WxHxD approx. 670 x 260 x 285 mm



2x round brush attachment



Jet nozzle attachment



Universal cleaning attachment



Angle attachment



Fleece



Measuring cup

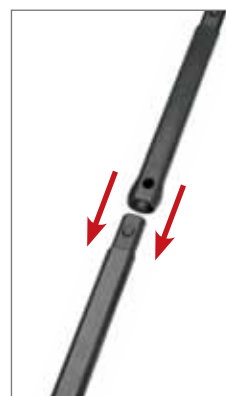

Extendable insertable tube



Floor brush



Round brush attachment



Window wiper



Angle attachment



### Steam cleaner DR 3280

- Steam cleaner, cleans, disinfects and degreases without limescale residues or streaks left behind from cleaning
- 4 bar steam pressure
- Approx. 1.5 litre water tank
- Stainless steel boiler
- Control lamps (mains and standby)
- Safety tank lid with pressure relief valve
- Overheating protection
- On/off switch protected against water spray
- Practical open carrying handle
- Smooth-running wheels
- Steam control on the handle
- Additional locking button for continuous operation
- Incl. 10 accessories:  
2-part extendable insertable tube, floor brush with cloth holder, non-woven cloth, window wiper, 2 jet nozzle attachments, 2 round brush attachments of different sizes, funnel, measuring beaker
- Integrated accessory compartment
- 220–240 V, 50/60 Hz, 1500 W
- WxHxD approx. 670 x 260 x 285 mm



### High-pressure cleaner HDR 3597

- Mobile high-pressure cleaner with 2 large wheels for use in areas of gentle care like cars, motorcycles, bicycles, and also for powerful cleaning, such as sidewalks, garden furniture/ tools, etc.
- Approx. 90 bar
- Delivery volume: 300 l max./h (5 l max./min.)
- Area capacity: approx. 20 m<sup>2</sup>/h
- Inlet temperature: 40 °C max.
- 1400 W max.
- Integrated water filter for protection of the pump against entry of dirt
- Large work reach by 5 m long connection cable and 5 m long high-pressure hose
- Compact housing with low weight (5.7 kg)
- Quick, clean and easy use of detergents with the practical detergent bottle (300 ml)
- Adjustable high-pressure nozzle
- High-pressure gun
- On/off switch (splashproof)
- Practical cable and hose winding on the unit for clean and space-saving storage
- Additional accessories can be stored on the unit
- Incl. carrying handle
- 230 V, 50 Hz, 1400 W
- WxHxD approx. 255 x 480 x 245 mm



Incl. cleaning agent bottle (300 ml)



Incl. practical cable reel



Mobile use – gentle and powerful cleaning

● Art. no. 283 013  
EAN 4 006 160 830 132 PU 1



● Art. no. 282 927  
EAN 4 006 160 829 273 PU 1





Fleece attachment for thorough cleaning



Window-cleaning attachment, cleans without streaks and limescale residue



Accessories: 2x microfiber cloth, measuring beaker, window cleaner, nozzle, brush, carpet glider attachment



Space-saving storage by easy separation of the components



Accessories: Carpet glider attachment, 2x microfiber cloth



## Steam mop DR 3539

## Steam mop DR 3431



- Steam cleaner cleans, disinfects and removes grease at 100°C without grease marks and residues
  - Suitable for different surfaces: e.g. laminates, wooden floors, marble, rubber, slate, ceramics
  - Cleans fabric surfaces such as carpets, mats and cushions
  - Environmentally friendly and hygienic cleaning without the use of chemicals
  - Kills bacteria through high steam power
  - Maximum disinfection and intensive cleaning
  - Ready to use in around 30 seconds
  - Approx. 300 ml water tank
  - Use for up to 30 min. on a full tank
  - Up to 25 g steam/min.
  - Carpet glider attachment
  - Aluminium telescopic tube
  - Removable handle and nozzle for easy use by hand
  - Accessories: 2x microfiber cloth, measuring beaker, window cleaner, nozzle, brush
  - Long lead, approx. 5.0 m
  - Electric lead take-up
  - Fire protection fuse
- 220–240 V, 50/60 Hz, 1500 W
  - W x H x D approx. 260 x 1200 x 210 mm

- Steam cleaner cleans, disinfects and removes grease at 100°C without grease marks and residues
  - Suitable for different surfaces: e.g. laminates, wooden floors, marble, rubber, slate, ceramics
  - Cleans fabric surfaces such as carpets, mats and cushions
  - Environmentally friendly and hygienic cleaning without the use of chemicals
  - Kills bacteria through high steam power
  - Maximum disinfection and intensive cleaning
  - Ready to use in around 30 seconds
  - Approx. 500 ml water tank, detachable
  - Use for up to 40 mins on a full tank
  - Up to 35 g steam/min.
  - Continuously adjustable steam quantity
  - Space-saving storage with folding handle
  - Accessories: 2 x microfiber cloth, carpet glider attachment, mMeasuring beaker
  - Long lead, approx. 5.0 m
  - Electric lead take-up
  - Fire protection fuse
- 220–240 V, 50 Hz, 1500 W
  - W x H x D approx. 315 x 1120 x 190 mm



Space-saving folding handle and detachable water tank



**Window cleaner**  
WC 3528

- Rechargeable battery-operated window cleaner set for daily use
  - Streak-free, time-saving, and hygienic cleaning for example of flat surfaces, windows, glass doors, mirrors, shower stalls, car windows etc.
  - 2-in-1 cleaning/suction function
    - drip-free cleaning by 270 mm wide suction nozzle
    - thorough cleaning by 310 mm wide micro fleece attachment
  - High-power ni-mh battery for up to 40 min. cleaning time
  - Included spraying bottle and micro fleece attachment (machine-washable)
  - Easy handling because of low weight (600 g)
- 
- Charging power supply: 230–240 V, 50/60 Hz
  - Battery: 3.6 V, 1500 mAh
  - W x H x D approx. 270 x 110 x 360 mm



Incl. spraying bottle



Micro fleece cloth pad for cleaning (310 mm, removable)



Width suction nozzle for cleaning free of streak (270 mm)





**Table vacuum cleaner**  
TS 3530

- Mini table vacuum cleaner
- Suction function
- Easily drainable dust-collecting container – Bagless technology
- Dirt container (easy to clean)
- On/off switch
- Light weight (130 g)
- Promotional packaging
- Battery operated:  
2x 1.5 V AA batteries (not included)
- WxHxD approx. 105 x 70 x 85 mm

**Battery vacuum cleaner**  
AKS 827

- With 3 rechargeable Ni-Mh batteries
- Nozzle for small gaps, brush nozzle
- Permanent dust filter, washable
- Charge control lamp (LED)
- Charger mains adapter
- Foot/wall mounting (installation materials not supplied)
- Charger mains adapter: 230 V, 50 Hz
- Rechargeable battery: 3.6 V, 1400 mAh
- WxHxD approx. 100 x 130 x 310 mm

**Battery wet/dry vacuum cleaner**  
AKS 828

- Wet/dry vacuum cleaner
- Powerful battery vacuum cleaner with three rechargeable batteries
- Permanent dust filter, washable
- Charge control lamp (LED)
- Charger mains adapter
- Accessories: Recess nozzle, attachment for wet vacuuming, wall mounting
- Charger mains adapter: 230 V, 50 Hz
- Rechargeable battery: 3.6 V, 1400 mAh
- WxHxD approx. 110 x 130 x 380 mm



**Mixed packaging – 3 colors**

Art. no. 263 611  
EAN 4 006 160 636 116 PU 12



Art. no. 281 044  
EAN 4 006 160 810 448

PU 6



Art. no. 281 052  
EAN 4 006 160 810 523

PU 6





98

### **NEW!** Battery vacuum cleaner AKS 832

- Wet/dry vacuum cleaner
- Powerful battery vacuum cleaner with 10 rechargeable batteries
- Permanent dust filter (washable)
- Charge control lamp (LED)
- 12 V and battery operation possible
- Direct-Drive function: with fully discharged battery, the vacuum cleaner can be used immediately in 12 V operation
- Cable storage compartment
- Accessories: 2x crevice nozzle (1x 13 cm, 1x 26 cm), attachment for wet vacuuming, brush nozzle, 12 V adapter cable
- Charger mains adapter: 230 V, 50 Hz
- Rechargeable battery: 12 V / Battery (NiMh), 1400 mAh
- W x H x D approx. 125 x 130 x 400 mm

### Hand vacuum cleaner HS 2631

- Hand vacuum cleaner for vacuuming of: furniture, upholstery, frames, curtains, books, computers, cars, and much more
- Compact size: 24 x 12 x 15 cm
- Permanent dust filter
- Easy to clean
- 6 m cable
- Low weight
- Vertical storage (space saving)
- Accessories: flexible „vacuum snout“ with crevice nozzle, small and large brush, shoulder strap
- 230 V, 50 Hz, 700 W max.
- W x H x D approx. 110 x 185 x 360 mm



Attachment for wet vacuuming



360° brush nozzle

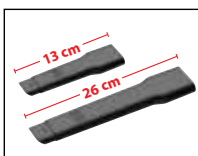

Extra-long crevice nozzles, for example, for use in the car



● Art. no. 281 055  
EAN 4 006 160 810 554 PU 4



● Art. no. 282 197  
EAN 4 006 160 821 970 PU 6





**B**



**A**

**Floor vacuum cleaner**  
BS 1292

- 4-layer micro-filter system
  - Metal suction tube
  - Switchable floor brush
  - Bag full display
  - Practical carrying handle
  - Automatic cable rewind
  - Space-saving parking aid
  - 2-fold accessories: brush/crevice nozzle
- 220–240 V, 50/60 Hz, 1000 W
  - W x H x D approx. 245 x 229 x 316 mm

**Spare bags:**

SSB 101  
Art. no. 282 047  
EAN 4 006 160 820 478

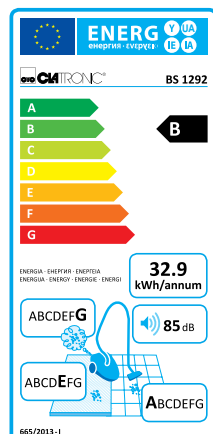

**NEW!** Floor vacuum cleaner  
BS 1300

- 4-layer micro-filter system
  - Stainless steel suction tube
  - Switchable floor brush
  - Bag full display
  - Practical carrying handle
  - Automatic cable rewind
  - Space-saving parking aid
  - 2-fold accessories: combined brush/crevice nozzle
- 220–240 V, 50/60 Hz, 700 W
  - W x H x D approx. 256 x 205 x 310 mm

**Spare bags:**

SSB 98  
Art. no. 282 193  
EAN 4 006 160 821 932

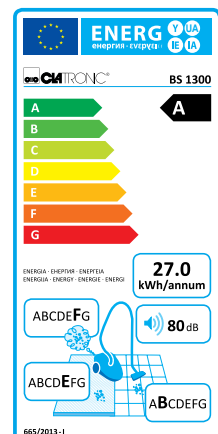



**A** **ELECTRONIC**



**A** **ELECTRONIC**

**Floor vacuum cleaner**  
BS 1295

- Electronic power adjustment
- 4-layer micro-filter system
- Includes HEPA exhaust filter
- Stainless steel suction tube (approx. 84 cm length)
- Extra large operation range (approx. 8.30 m)
- Switchable floor brush
- Bag full display
- Rubberised rollers (ideal for sensitive floors)
- Practical carrying handle
- Automatic cable rewind
- Space-saving parking aid
- Integrated accessory tray
- 2-fold accessories: combined brush/crevice nozzle

- 220–240 V, 50/60 Hz, 800 W
- W x H x D approx.  
255 x 205 x 370 mm

**Spare bags:**

SSB 101  
Art. no. 282 193  
EAN 4 006 160 820 932

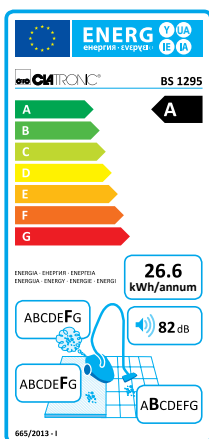

**Floor vacuum cleaner**  
BS 1288

- Electronic power adjustment
- 4-layer micro-filter system
- Includes HEPA exhaust filter
- Stainless steel suction tube (approx. 85 cm length)
- Extra large operation range (approx. 8.30 m)
- Switchable floor brush
- Bag full display
- Rubberised rollers (ideal for sensitive floors)
- Practical carrying handle
- Automatic cable rewind
- Space-saving parking aid
- Integrated accessory tray
- 2-fold accessories: combined brush/crevice nozzle

- 230 V, 50 Hz, 800 W
- W x H x D approx.  
280 x 240 x 460 mm

**Spare bags:**

SSB 101  
Art. no. 282 047  
EAN 4 006 160 820 478

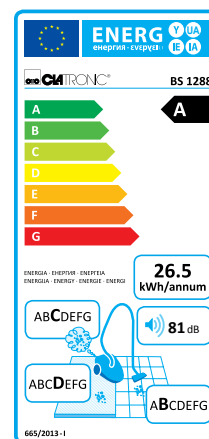

Art. no. 271 706  
EAN 4 006 160 717 068 PU 1



Art. no. 271 691  
EAN 4 006 160 716 917 PU 1

Art. no. 271 701  
EAN 4 006 160 717 013 PU 1







**Floor vacuum cleaner**  
BS 1296

**NEW!** Floor vacuum cleaner  
BS 1301

- Electronic power adjustment
- 4-layer micro-filter system
- Includes HEPA exhaust filter
- Stainless steel suction tube (approx. 84 cm length)
- Extra large operation range (approx. 8.30 m)
- Switchable floor brush
- Bag full display
- Rubberised rollers (ideal for sensitive floors)
- Practical carrying handle
- Automatic cable rewind
- Space-saving parking aid
- 2-fold accessories: combined brush/crevice nozzle

- 220–240 V, 50/60 Hz, 700 W
- WxHxD approx.  
280 x 240 x 320 mm

**Spare bags:**

SSB 101  
Art. no. 282 047  
EAN 4 006 160 820 478

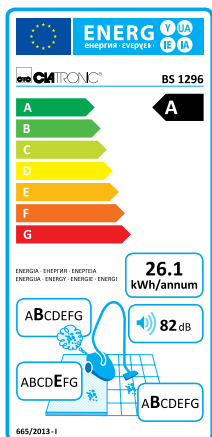

- Electronic power adjustment
- 4-layer micro-filter system
- Includes HEPA exhaust filter
- Stainless steel suction tube (approx. 84 cm length)
- Extra large operation range (approx. 8.30 m)
- Switchable floor brush
- Incl. parquet brush
- Bag full display
- Rubberised rollers (ideal for sensitive floors)
- Practical carrying handle
- Automatic cable rewind
- Space-saving parking aid
- 3-fold accessories: crevice nozzle, upholstery nozzle, 360° brush attachment

- 220–240 V, 50/60 Hz, 700 W
- WxHxD approx. 291 x 246 x 457 mm

**Spare bags:**

SSB 101  
Art. no. 282 047  
EAN 4 006 160 820 478

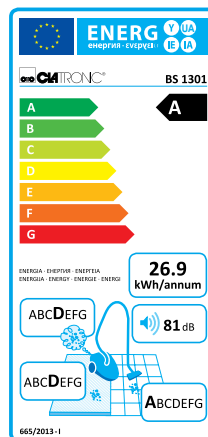

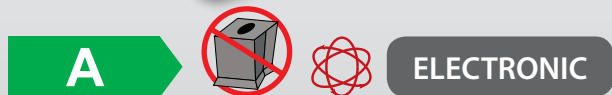

**Floor vacuum cleaner**  
BS 1293

**NEW!** Floor vacuum cleaner  
BS 1298

- Eco-Cyclon
- Bagless filter technology
- 4-layer micro-filter system
- Includes HEPA filter
- Metal suction tube
- Switchable floor brush
- Rubberised rollers (ideal for sensitive floors)
- Practical carrying handle
- Automatic cable rewind
- Space-saving parking aid
- 2-fold accessories: combined brush/crevice nozzle
  
- 220–240 V, 50/60 Hz, 1000 W
- W x H x D approx. 235 x 290 x 365 mm

- Eco-Cyclon twin spin floor vacuum cleaner with powerful max. 700 watt motor
- Bagless Cyclon Twin Spin technique allows continual high suction power
- Electronic power adjustment
- 4-layer filter system
- Includes HEPA filter
- Stainless steel suction tube (approx. 84 cm length)
- Extra large operation range (approx. 8.30 m)
- Switchable floor brush
- Rubberised rollers (ideal for sensitive floors)
- Practical carrying handle
- Automatic cable rewind
- Space-saving parking aid
- 3-fold accessories: combined brush/crevice nozzle, upholstery nozzle

- 230 V, 50 Hz, 700 W
- W x H x D approx. 245 x 260 x 330 mm

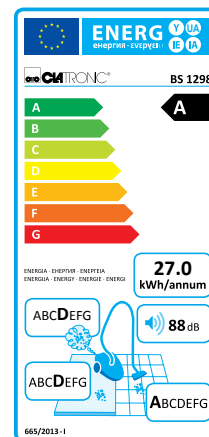
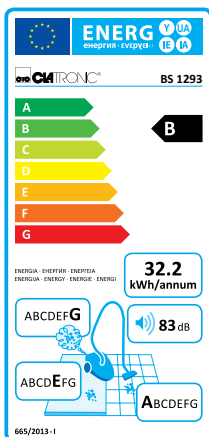

- Art. no. 271 697  
EAN 4 006 160 716 979 PU 1
- Art. no. 271 702  
EAN 4 006 160 717 020 PU 1

- Art. no. 271 710  
EAN 4 006 160 717 105 PU 1
- Art. no. 271 709  
EAN 4 006 160 717 099 PU 1





**A**   **ELECTRONIC**

**2in1**  **Stainless steel**

**NEW!** Floor vacuum cleaner  
BS 1294

Wet and dry vacuum cleaner  
BS 1285

- Floor vacuum cleaner with energy-saving 700 Watt
- Electronic power adjustment
- Includes 2 HEPA filter
- Height-adjustable telescopic tube
- Adjustable floor brush
- Bagless filtertechnology (no need to purchase dust bags)
- Easy-to-empty, transparent dust-collecting container replaces conventional dust bag
- Tank volume: 1.25 l
- Motor protection filter (washable)
- Rubberised rollers (ideal for parquet floors)
- Automatic cable rewind
- Space-saving parking aid
- 3-fold accessories: combined brush/crevice nozzle, upholstery nozzle
- 220–240 V, 50/60 Hz, 700 W
- W x H x D approx. 365 x 265 x 285 mm

- Stainless steel housing
- Large and comfortable wet and dry vacuum cleaner with powerful 1600 watt max.
- Tank capacity: approx. 20 litre
- Multi filter system
- Incl. blower function, e.g. for easy removal of leaves
- Draws coarse dirt as effectively as liquids
- Optimal stability through 4 rollers
- Deflection rollers (360°) allow smooth and flexible working
- 2-part robust suction tube
- Overflow protection by float valve
- Practical holder on the vacuum cleaner for quick access and tidied accessory
- 5 m cable allows large operation range
- Accessories: brush/crevice nozzle, wet/dry brush, washable permanent filter
- 220–240 V, 50/60 Hz, 1600 W max.
- W x H x D approx. 340 x 500 x 340 mm

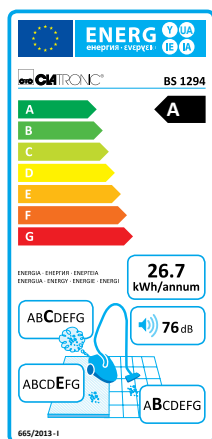

Also ideal for the use on laminate, carpets etc.

Accessories: brush nozzle and crevice nozzle

Art. no. 271 711  
EAN 4 006 160 717 112 PU 1

Art. no. 271 703  
EAN 4 006 160 717 037 PU 1

Art. no. 271 686  
EAN 4 006 160 716 863 PU 1



MC 3240



MC 3241



### Textile cleaner MC 3240 / MC 3241

#### MC 3240

- Ideal for the easy removal of lint/pilling
- Handy size
- Metal lint grid
- Transparent lint container
- On/off switch
- Battery operation: 2x 1.5 V (UM3) (batteries not included)
- WxHxD approx. 36 x 76 x 76 mm

#### MC 3241

- Ideal for the easy removal of lint/pilling
- Handy size
- Metal lint grid
- Transparent lint container
- On/off switch
- Battery operation: 2x 1.5 V (UM3) (batteries not included)
- WxHxD approx. 60 x 85 x 170 mm

### Luggage scale GW 3549

- Handy luggage scale
- Ergonomically designed
- Heavyduty tie-down straps
- Precise sensor measuring system
- Easily readable LCD display
- Promotional display packaging
- Measurement range up to 40 kg (subdivided into 100 g steps)
- Automatic switch-off
- On/off switch
- Battery operation: 1x CR2032 (battery included)
- WxHxD approx. 100 x 25 x 36 mm



Heavyduty tie-down straps



Promotional display box

Contents of the display box: 20 units

### Electronic bathroom scale PW 3368

- Electronic glass bathroom scale with easy-to-read LCD display
- Weighing units in kg, lb, st (convertible)
- Measurement range of 2.5–150 kg (subdivided into 100 g steps)
- Low-maintenance standing surface
- Non-slip feet ensuring secure base
- Automatic switch-off (prolongs battery life)
- Battery operation: 1x CR 2032 (battery not included)
- WxHxD approx. 330 x 300 x 250 mm

● Art. no. 263 063 (MC3240)  
EAN 4 006 160 630 633 PU 20  
● Art. no. 263 062 (MC 3241)  
EAN 4 006 160 074 314 PU 20



● Art. no. 263 623  
EAN 4 006 160 636 239 PU 1



● Art. no. 271 666  
EAN 4 006 160 716 665 PU 6







 **Stainless steel**

**Electronic bathroom scale**  
PW 3369

- Electronic glass bathroom scale with easy-to-read LCD display
- Weighing units in kg, lb, st (convertible)
- Measurement range of 2.5–150 kg (subdivided into 100 g steps)
- Low-maintenance standing surface
- Non-slip feet ensuring secure base
- Automatic switch-off (prolongs battery life)
  
- Battery operation: 1x CR 2032 (battery not included)
- WxHxD approx. 320 x 320 x 25 mm

**Electronic bathroom scale**  
PW 3370

- Electronic stainless steel scale with easy-to-read LCD display (blue illuminated)
- Weighing units in kg, lb, st (convertible)
- Measurement range of 2.5–150 kg (subdivided into 100 g steps)
- Low-maintenance standing surface
- Non-slip feet ensuring secure base
- Automatic switch-off (prolongs battery life)
  
- Battery operation: 3x AAA (batteries not included)
- WxHxD approx. 330 x 330 x 25 mm



### Digital thermometer FT 3617

FT 3618

### Sterilizer BFS 3616

### Baby food warmer BKW 3615

- Digital express thermometer with flexible measuring tip
  - Easily readable 3-digit LED display
  - Easy one-button operation
  - Precise body temperature measurement
  - Measurement range: 32 to 42.9 °C
  - Beep at the end of the measurement
  - Warning sound with a temperature above 37.8 °C
  - Automatic storage of the last value
  - Low-battery indication on the display
  - Free of mercury
  - Easy to clean
  - Protection cap for the sensor
  - Protected against splashing water
  - Automatic shutdown of the measuring function, increases the battery life time
  - Certified according to EN12470-3
  - Battery operation (batteries included)
  - W x H x D approx. 28 x 148 x 20 mm
- Gentle testing in the mouth
  - Easily readable 3-digit LCD display
  - Easy one-button operation
  - Precise body temperature measurement
  - Measurement range: 32 to 42.9 °C
  - Beep at the end of the measurement
  - Warning sound with a temperature above 37.8 °C
  - Automatic storage of the last value
  - Low battery indication on the display
  - Free of mercury
  - Easy to clean
  - Protection cap for the sensor
  - Protected against splashing water
  - Automatic shutdown of the measuring function, increases the battery life time
  - Certified according to EN12470-3
  - Battery operation (batteries included)
  - W x H x D approx. 60 x 40 x 40 mm
- Disinfection of up to 6 bottles and accessories
  - Removal of all harmful household bacteria
  - Up to 3 hours of "sterility" with unopened lid
  - Sterilization without chemical additives
  - Incl. removable bottle holder, gripper and measuring cup
  - Suitable for all standard bottles
  - Control lamp
  - 220–240 V, 50 Hz, 500 W
  - W x H x D approx. 205 x 320 x 195 mm
- Gentle and even warming of baby food
  - Suitable for standard bottles and glasses (up to 70 mm Ø)
  - Stepless temperature control from approx. 40 °C to 100 °C
  - Keep warm function
  - Accessory cup and lid
  - 220–240 V, 50 Hz, 100 W
  - W x H x D approx. 140 x 150 x 140 mm



Incl. removable bottle holder, gripper and measuring cup



Keep warm function



Gentle and even warming of baby food



Art. no. 263 714 PU 12  
EAN 4 006 160 637 144



Art. no. 263 715 PU 12  
EAN 4 006 160 637 151



Art. no. 263 713 PU 2  
EAN 4 006 160 637 137



Art. no. 263 712 PU 3  
EAN 4 006 160 637 120





**Foot massager**  
FM 3389

- Intense whirlpool effect
- Massage burls for stimulating the foot reflex zones
- Additional massage roller, detachable, for selective foot reflex zone massage
- Heated footrest
- 4-level switches:  
0 = off  
1 = massage  
2 = warm/whirl  
3 = warm/whirl/massage
- Can be used with and without water
- Splash guard, detachable
- Water level mark
- Spout
- Large rubber feet for slip-proof stand
  
- 230 V, 50 Hz, 90 W
- WxHxD approx. 300 x 120 x 380 mm



**Infra-red massaging rod**  
MSI 2571

- 3 functions:
  - massage only
  - infra-red only
  - massage and infra-red
- 4 different massage accessories:
  - 2 point concentrators
  - surface massager
  - face massager
- Extremely quiet motor
  
- 230 V, 50 Hz, 13 W
- WxHxD approx. 240 x 70 x 75 mm

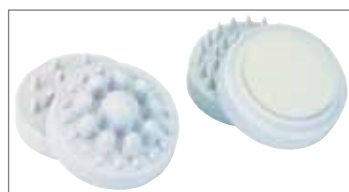

4 different massage accessories

**Manicure/pedicure set**  
MPS 2681

- Ergonomically shaped handle with on/off switch
- 8 different attachments:
  - 2 polishing attachments
  - 1 callus rasping attachment
  - 2 nail file attachments (rough/fine)
  - 1 large grinding cone
  - 2 small grinding cones (peaked/blunt)
- Modeling stick
- Rechargeable battery
- With fully discharged battery the device can be used in mains operation immediately
- Charging indicator light
- Practical storage box
  
- Power supply:  
Primary mains adapter: 100-240 V, 50/60 Hz
- Output voltage: DC 2.4 V  
Secondary mains adapter: 3.6 V (adapter output)
- Output current:  
Secondary mains adapter: 500 mA
- Rechargeable battery:  
battery pack 2.4 V, 600 mAh
- Protection class: II
- WxHxD approx. 210 x 70 x 150 mm





2in1

108

### Nose and ear hair remover NE 3595

- Conveniently and simply removes troublesome hairs in the nose and ears
- Includes light for improved personal grooming
- Removable fine-steel shearing head for cleaning
- On/off switch
- Incl. covering cap for the shearing head
- Battery operation: 1x 1.5 V (AA) (batteries not included)
- WxHxD approx. 30 x 130 x 35 mm



Includes light for improved personal grooming



Promotional Packaging

### Hair and beard trimmer HSM 3430

- Stainless steel precision shaving head for uniform haircut
- Stainless steel blade
- Stepless cutting length adjustment for efficient use of the comb attachments
- 4 comb attachments: 3, 6, 9, 12 mm
- Rubberized inlay for non-slip handling
- Accessories:
  - 4 comb attachments
  - Cleaning brush
  - Shearing head protection
  - Hanging loop
- 230–240 V, 50 Hz, 10 W max.
- WxHxD approx. 65 x 55 x 200 mm



### Hair trimmer set HSM 3441 NE

- Hair and beard trimmer:**
- Stainless steel precision shaving head for uniform haircut
  - Stainless steel blade
  - Stepless cutting length adjustment for efficient use of the comb attachments
  - 4 comb attachments: 3, 6, 9, 12 mm
  - Soft touch inlay for non-slip handling
  - Accessories: 4 comb attachments, cleaning brush, shearing head protection, comb, hanging loop
  - 230–240 V, 50 Hz, 10 W max.
  - WxHxD approx. 65 x 55 x 200 mm

**Nose and ear hair remover:**

- Gently and comfortably removes unsightly nose and ear hair
- Stainless steel shaving head, can be detached for cleaning
- Incl. cap for shaving head
- Battery operation: 1x 1.5 V (AA) (batteries not included)
- WxHxD approx. 28 x 130 x 30 mm

Art. no. 263 687  
EAN 4 006 160 636 871 PU 12



Art. no. 263 559  
EAN 4 006 160 635 591 PU 12



Art. no. 263 571  
EAN 4 006 160 635 713 PU 10







Battery

2in1

Battery



Ceramic

### Hair and beard trimmer HSM/R 3313

- Battery mode
- Stainless steel precision shaving head for uniform haircut
- Adjustable cutting lengths – 3 mm (without comb attachment); 5, 9, 13, 16 mm (with comb attachment) – for professional working
- Removable comb attachment
- Mechanically folding shaving head for easy cleaning
- Easy to handle due to ergonomically shaped grip
- Soft touch handle inlay
- LED charge display
- Charging station/stand including rubberised feet for stability
- Includes six accessories: charging station/stand, mains charger, comb, cleaning brush, scissors, comb attachment
- Mains charger: 100–240 V, 50/60 Hz  
Battery (NiMH): 800 mAh
- W x H x D approx. 50 x 190 x 50 mm



### Men's shaver incl. nose/ ear hair remover HR 3236

- **Men's shaver:**
  - 2 level shaving system
  - Hair cutter
  - Removable double shaving head for the cleaning of the blades
  - Includes spare shaving foil, cleaning brush, oil, storage bag
- **Nose/ear hair remover:**
  - Stainless steel blade
  - Blade can be removed for cleaning under running water
  - Rotating shearing
- **General:**
  - Battery/AC adapter
  - On/off switch
  - Skid-proof handle area
  - Includes textile bag
- 100–240 V, 50/60 Hz, 3 W
- W x H x D approx. 56 x 150 x 40 mm



### Hair straightener HC 3361

- Ideal for fashionable hairstyles
- Full ceramic plates for even and gentle heat distribution
- Straightens the hair without problems due to the prolonged constant temperature
- Short heating period
- Handy design
- Soft touch
- On/off switch
- Hanging loop
- 230 V, 50 Hz, 20 W
- W x H x D approx. 43 x 45 x 285 mm



4in1

110

### Multicurler 4 in 1 MC 3020

- 2in1: hair smoother with interchangeable plates for wavy or smooth hair
  - 2in1: curling tongs and curling iron
  - Ideal for fashionable hairstyles
  - Curling tongs chrome-plated
  - Removable brush attachment
  - Turn-lock fastener for attachments
  - On/off switch, indicator light
  - Ergonomic design handle
  - Cable attached via 360° turnable joint
  - Overheating protection
- 230 V, 50 Hz, 20 W
  - WxHxD approx. 315 x 76 x 41 mm

### Hair crimper HC 3392

- Hair crimper chromed
  - Trouble-free styling due to the constant, long-lasting temperature
  - Rapid heating
  - Indicator light
  - Soft touch housing
  - Cable attached via 360° turnable joint
  - On/off switch
  - Incl. setting-down aid
- 230 V, 50 Hz, 25 W
  - WxHxD approx. 280 x 35 x 70 mm

### Hot air styler HAS 2712

- 2 power level
  - Roll key for accessories
  - Ergonomically formed
  - Cable with swivel cord 360°
  - Safety cut-out
- 230 V, 50 Hz, 300 W
  - WxHxD approx. 320 x 50 x 50 mm



● Art. no. 271 544  
EAN 4 006 160 715 446 PU 12



● Art. no. 263 183  
EAN 4 006 160 631 838 PU 12



● Art. no. 271 129  
EAN 4 006 160 711 295 PU 12





**Hot air styler**  
HAS 3019

- Powerful 550 watt motor
- 2 power level + cold level Cool Shot
- Incl. 3 accessories: volume styler, round brush, regular brush
- Roll-out button for attachments
- Switchable voltage
- Overheating protection
- 110/230 V, 50/60 Hz, 550 W
- WxHxD approx. 305 x 45 x 45 mm

**Hair dryer**  
HT 3393

- Compact travelling hair dryer
- 2 temperature/power settings
- Removable shaped nozzle, rotatable through 360°
- Rubber profile on the casing avoid slipping
- Overheating protection
- Hanging loop
- 230 V, 50 Hz, 1200 W
- WxHxD approx. 111 x 210 x 75 mm

**Hair dryer**  
HT 3428

- Compact travelling hair dryer
- 2 temperature/power settings
- Soft touch housing – rubberised surface to prevent slipping when putting down
- Includes see-through bag for practical storage and when travelling
- Hanging loop
- 230 V, 50 Hz, 1200 W
- WxHxD approx. 150 x 210 x 75 mm



Incl. volume styler, round brush, regular brush

● Art. no. 271 548  
● EAN 4 006 160 715 484 PU 12



● Art. no. 263 184  
● EAN 4 006 160 631 845 PU 12



● Art. no. 263 557  
● EAN 4 006 160 635 577 PU 12  
● Art. no. 264 557  
● EAN 4 006 160 645 576 PU 12





112

**Hair dryer**  
HTD 3429

- Compact travelling hair dryer
- Folding handle
- 2 temperature/power settings
- Removable shaped nozzle, rotatable through 360°
- Soft touch housing – rubberised surface to prevent slipping when putting down
- Includes volume diffuser and see-through bag for practical storage and when travelling
- Switchable voltage: 110/230 V
- Hanging loop
  
- 230 V, 50 Hz, 1300 W max.
- WxHxD approx. 170 x 235 x 75 mm

**Hair dryer**  
HTD 3614

- Professional hair dryer with powerful 2000 watt
- 3 temperature/power settings
- 2 speed settings
- Cool Shot
- Professional volume diffuser and shaping nozzle
- Rubberised surface to prevent slipping when putting down
- Overheating protection
- Hanging loop
  
- 230 V, 50 Hz, 2000 W
- WxHxD approx. 210 x 235 x 90 mm

● Art. no. 263 558  
EAN 4 006 160 635 584 PU 12  
● Art. no. 264 558  
EAN 4 006 160 645 583 PU 12



● Art. no. 263 711  
EAN 4 006 160 637 113 PU 6







### Professional hairstyler HTD 3055 Profi

- Professional hairstyler with 2000 watt
- 3 temperature/power settings
- 2 speed settings
- Cool Shot
- Professional volume diffuser and shaping nozzle
- Air intake filter (removable)
- Rubberised housing
- Avoid slipping
- Soft-touch grip
- Overheating protection
- Hanging loop
  
- 230 V, 50 Hz, 2000 W max.
- W x H x D approx. 270 x 270 x 90 mm

### Hair dryer HTD 2939

- Professional hairstyler with 2000 watt
- 2 temperature/speed settings
- Cool Shot
- Professional finger diffuser and styling nozzle
- Air intake filter, removable
- Safety thermal cut-out
- Hanging loop
  
- 230 V, 50 Hz, 2000 W
- W x H x D approx. 260 x 240 x 90 mm

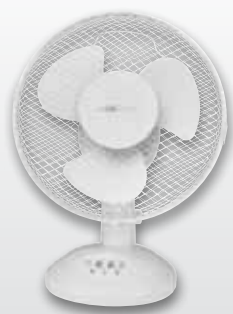

Ø 23 cm



Ø 30 cm



Ø 40 cm

114

**Table fan**  
VL 3601

- Oscillating (can be switched off)
- Adjustable angle of inclination
- Metal protection grid
- Safe base
- Ø approx. 23 cm
- 2 speed level
- 3-level switches (0-1-2)
- Practical carrying handle
- 220–240 V, 50/60 Hz, 30 W
- WxHxD approx. 275 x 375 x 220 mm

**Table fan**  
VL 3602

- Oscillating (can be switched off)
- Adjustable angle of inclination
- Metal protection grid
- Safe base
- Ø approx. 30 cm
- 3 speed level
- 4-level switches (0-1-2-3)
- Practical carrying handle
- 220–240 V, 50/60 Hz, 40 W
- WxHxD approx. 340 x 480 x 245 mm

**Standing fan**  
VL 3603 S

- Oscillating (can be switched off)
- Height-adjustable
- Adjustable angle of inclination
- Metal protection grid
- Safe base
- Ø approx. 40 cm
- 3 speed level
- 4-level switches (0-1-2-3)
- Practical carrying handle
- 220–240 V, 50/60 Hz, 45 W
- WxHxD approx. 430 x 1250 x 640 mm

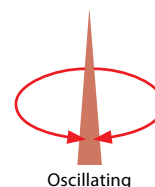
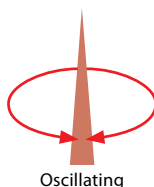
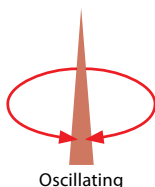

● Art. no. 263 698  
EAN 4 006 160 636 987 PU 4



● Art. no. 263 699  
EAN 4 006 160 636 994 PU 4



● Art. no. 263 700  
EAN 4 006 160 637 007 PU 3





**A**

**Tower fan**  
T-VL 3546

**Air conditioning unit**  
CL 3542

- 75° oscillating (can be switched off)
- Space-saving
- Quiet running
- Protection grid
- Safe base
- 3 speed level
- 4-level switches (0-1-2-3)
- 120 minute timer
- Practical carrying handle
- Height: 76 cm
  
- 220-240 V, 50 Hz, 50 W
- W x H x D approx. 220 x 755 x 220 mm

- Cooling capacity: 7000 BTU (2,05 kW)
- Coolant R 410 A
- Air recirculation: up to 380 m<sup>3</sup>/h
- 3 functions: cooling, dehumidifying, blowing
- Sound level: 57 dB(A)
- Energy efficiency class A
- 4 x filters, removable
- 24-hour timer
- Sleep mode
- Fan with 2 speed level
- Multifunction LED display
- 4 easy-running rollers for easy transport
- Infrared remote control
- Incl. 1.5 m exhaust hose and window kit
  
- 220-240 V, 50 Hz, 880 W
- W x H x D approx. 320 x 730 x 370 mm

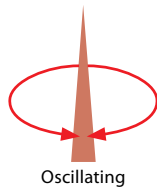

Oscillating



Incl. infrared remote control



Incl. exhaust hose

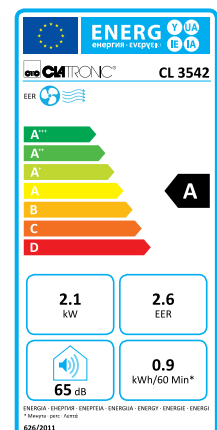

Art. no. 283 043  
EAN 4 006 160 830 439

PU 2



Art. no. 283 039  
EAN 4 006 160 830 392

PU 1





116

### Convective heater KH 3077

- Mobile heat – also suitable for heating summerhouses, garages and conservatories
  - 3 heat settings (750/1250/2000 W)
  - Infinitely adjustable thermostat
  - Automatic temperature controller
  - Indicator light
  - Convenient built-in carry handles for easy transport
  - Low-noise operation
  - Overheating protection
  - Wall installation possible (installation material supplied)
- 220–240 V, 50Hz, 1900–2200 W
  - WxHxD (without feet) 570 x 110 x 375 mm
  - WxHxD (with feet) 570 x 195 x 420 mm

### Convective heater KH 3433

- Mobile heat – also suitable for heating summerhouses, garages and conservatories
  - 3 heat settings (750/1250/2000 W)
  - Infinitely adjustable thermostat
  - Automatic temperature controller
  - Anti-frost function
  - Includes blower function
  - 3 control lamps
  - Convenient built-in carry handles for easy transport
  - Low-noise operation
  - Overheating protection
  - Wall installation possible (installation material supplied)
- 230 V, 50Hz, 2000 W
  - WxHxD (without feet) 670 x 440 x 110 mm
  - WxHxD (with feet) 670 x 480 x 110 mm

● Art. no. 281 963  
EAN 4 006 160 819 632 PU 2



● Art. no. 263 562  
EAN 4 006 160 635 621 PU 1





A+

A++

**Cool box**  
KB 3537

**Cool box**  
KB 3538

- Suitable for cooling and warming
- Perfect for camping, travel and shopping
- Capacity (gross capacity): ca. 25 litre max.
- Even cooling by integrated fan
- Powerful, maintenance-free Peltier cooling/heating system
- Energy saving function
- Double walled plastic casing with high quality isolation
- Special sealing rubber in the lid reduces condensation
- Control lights for cooling and warming function
- Foldable handle
- Removable lid
- Accessory: 12 V connecting cable (detachable), 230 V connecting cable (detachable)

- Power supply:
  - Mains adapter connection: DC 12 V, 40/48 W
  - Mains adapter connection: AC 220–240 V, ~ 50/60 Hz, 52/58 W, 11 W (ECO mode)

- WxHxD approx. 405 x 435 x 300 mm
- Energy class: A+

- Suitable for cooling and warming
- Perfect for camping, travel and shopping
- Capacity (gross capacity): ca. 30 litre max.
- Even cooling by integrated fan
- Powerful, maintenance-free Peltier cooling/heating system
- Energie saving function
- Double walled plastic casing with high quality isolation
- Special sealing rubber in the lid reduces condensation
- Control lights for cooling and warming function
- Foldable handle
- Removable lid
- Cable storage compartment
- Accessory: 12 V connecting cable, 230 V connecting cable

- Power supply:
  - Mains adapter connection: DC 12 V, 40/48 W
  - Mains adapter connection: AC 220–240 V, ~ 50/60 Hz, 52/58 W, 8 W (ECO mode)

- WxHxD approx. 405 x 435 x 300 mm
- Energy class: A++



For all standard 0.75/1.0/1.5-litre bottles

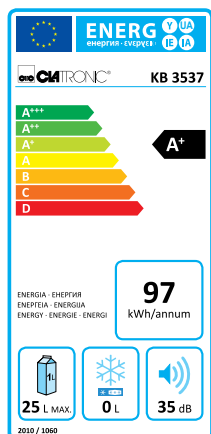

For all standard 0.75/1.0/1.5-litre bottles

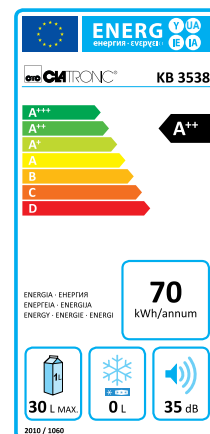





118

### Air dehumidifier LE 3612

- Dehumidification power: 12 L/24 h
- Air circulation in m<sup>3</sup>:
- Level 1: Approx. 100 m<sup>3</sup>/h
- Level 2: Approx. 140 m<sup>3</sup>/h
- LED display (blue illuminated)
- Humidity indicator
- Electronic humidity control
- The desired humidity can be set from 40 to 80 %
- 24 hour timer
- 1 L water tank (detachable)
- Fold-out carrying handle
- Convenient rollers
- Automatic stop + warning signal with full tank
- Low noise
- Removable air filter (easy to clean)
- Hose connector for permanent water drain
- Incl. water hose (1 m)
- On/off switch
- Coolant: R134A
- Ideal for rooms up to 15 m<sup>2</sup>
- 220–240 V, 50 Hz, 220 W
- WxHxD approx. 280 x 520 x 185 mm



LED display



Hose connector for permanent water drain

### Air humidifier LB 3599

- Silent air humidifier for a pleasant and healthy indoor climate
- Ionization function - especially fresh air by negatively charged ions counteracts dry air and skin, fatigue, indisposition, and common cold
- The desired humidity can be set from 40 to 95 %
- Automatic start/stop function when the set humidity is exceeded or fallen short of
- 24 hour timer (can be set from 1 to 24 h)
- Atomisation by means of ultrasound technology
- Including a replaceable ceramic filter for prevention of limescale
- Large transparent water tank with 5.2-litre capacity
- Acoustical signal when the water tank is empty
- Automatic switch off when tank is empty
- Easy to fill due to removable water tank
- Up to 64 hours non-stop operation
- Humidification performance approx. 0.3 l/h
- Suitable for rooms of up to 40 m<sup>2</sup>
- Controllable steam volume
- Steam outlet can be rotated through 360°
- 220–240 V, 50/60 Hz, 30 W
- WxHxD approx. 255 x 335 x 170 mm



Multi function display

● Art. no. 263 709  
EAN 4 006 160 637 090 PU 2



● Art. no. 263 696  
EAN 4 006 160 636 963 PU 4





**Air humidifier**  
LB 3488

- Silent air humidifier for a pleasant and healthy indoor climate
- Atomisation by means of ultrasound technology
- Including a replaceable ceramic filter for prevention of limescale
- Large transparent water tank with 3-litre capacity (blue illuminated during operation)
- Re-fill indicator for empty tank (red illuminated)
- Automatic switch-off when tank is empty
- Easy to fill due to removable water tank
- Up to 12 hours non-stop operation
- Humidification performance approx. 0.3 l/h
- Suitable for rooms of up to 30 m<sup>2</sup>
- Continuously adjustable steam quantity
- Steam outlet can be rotated through 360°
- Including a blue-lit decoration ring (illumination can be switched on/off)
- 220–240 V, 50/60 Hz, 30 W
- W x H x D approx. 140 x 335 x 280 mm



Removable, illuminated water tank



Indicator light (red when tank is empty)

**Fan heater**  
HL 3378

- 2 heat settings (1000/2000 watt)
- Cold (ventilator)
- Infinitely adjustable thermostat
- Indicator light
- Safe base
- Sturdy carrying handle
- Overheating protection
- 220–240 V, 50 Hz, 2000 W
- W x H x D approx. 230 x 138 x 262 mm

**Fan heater**  
HL 3379

- 2 heat settings (1000/2000 watt max.)
- Cold (ventilator)
- Infinitely adjustable thermostat
- Indicator light
- 2 different ways of setting up
- Safe base
- Sturdy carrying handle
- Overheating protection
- 220–240 V, 50 Hz, 1800–2000 W
- W x H x D approx. 248 x 120 x 250 mm



2 different ways of setting up

Art. no. 261 676  
EAN 4 006 160 616 767 PU 4



Art. no. 271 671  
EAN 4 006 160 716 719 PU 4



Art. no. 271 672  
EAN 4 006 160 716 726 PU 4





120

### Fan heater HL 3377

- 2 heat settings (1000/2000 watt)
- Oscillating (can be switched off)
- Cold (ventilator)
- Infinitely adjustable thermostat
- Safety contact switch for fire protection
- Safe base
- Sturdy carrying handle
- Overheating protection
- 220–240 V, 50 Hz, 2000 W
- W x H x D approx. 235 x 300 x 205 mm

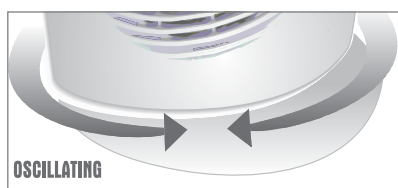

### **NEW!** Ceramic fan heater HL 3631

- PTC ceramic heater element for healthy, safe, quiet and efficient heating
- Low dust accumulation
- Quick and effective heating
- Long service life
- Robust and durable
- 7 level switches
- 2 heat settings (750/1500 W)
- Oscillating (can be deactivated)
- Cold setting (fan blower)
- Steplessly adjustable thermostat
- Safety switch for fire protection
- Stable stand
- Robust carry handle (foldable)
- Overheat protection
- 220–240 V, 50 Hz, 1500 W
- W x H x D approx. 191 x 267 x 141 mm



### Insect killer IV 3340

- Environmentally-friendly killing of mosquitoes/gnats/wasps/insects without chemicals or scents
- The insects are attracted by the UV light and killed by means of an electric wire mesh.
- Electric wire mesh voltage: 1500–2000 V on the mesh itself
- Covers a range of approx. 20 m<sup>2</sup>
- Specifically designed for use in closed rooms
- All-round use
- Same level of efficiency in daylight and artificial light
- Includes suspension device
- 220–240 V, 50/60 Hz, 4 W
- W x H x D approx. 160 x 230 x 100 mm

Art. no. 271 670  
EAN 4 006 160 716 702 PU 4



Art. no. 263 470  
EAN 4 006 160 637 403 PU 4



Art. no. 263 136  
EAN 4 006 160 631 364 PU 6



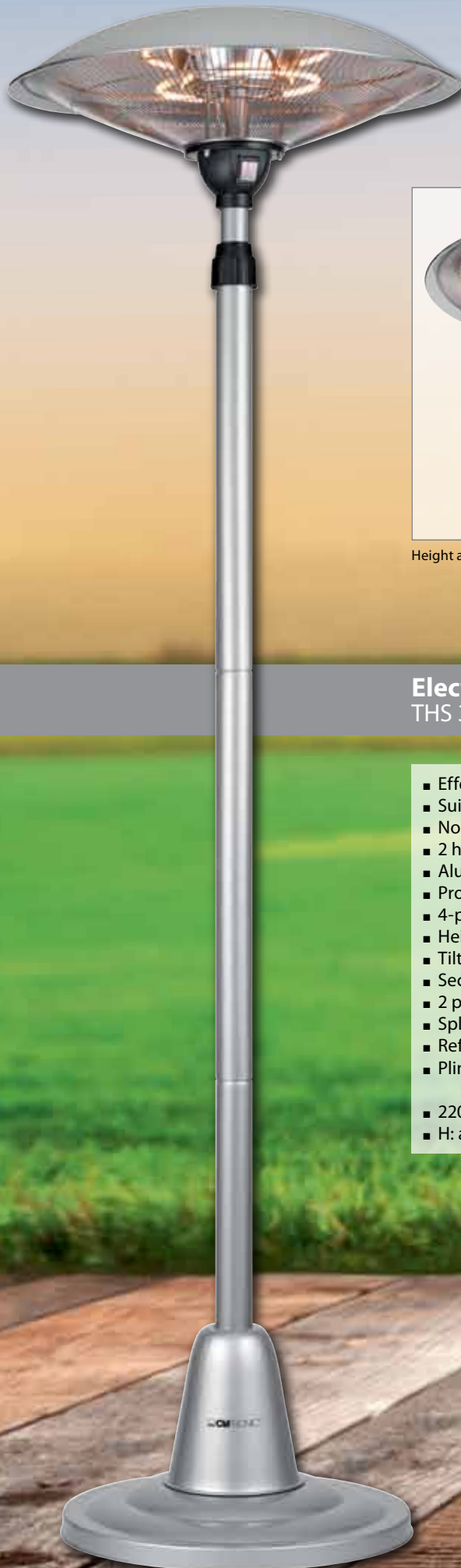

Height adjustable (192–210 cm)

## Electro patio heater THS 3541

121

- Effective, targeted, and immediate heating
- Suitable for well-ventilated indoor areas
- No noise, no smell
- 2 halogen heater elements
- Aluminium reflector
- Protective grill
- 4-part metal telescopic tube
- Height: 192–210 cm (steplessly adjustable)
- Tilt switch
- Secure stand / stable foot
- 2 power settings (1000/2000 watt)
- Splash proof (IP34)
- Reflector diameter: 61 cm
- Plinth diameter : 46 cm
  
- 220–240 V, 50 Hz, 2000 W
- H: approx. 229 cm; Ø 61 cm

Art. no. 283 038  
EAN 4 006 160 830 385

PU 1

CE 0063





**Filter sets**

**BS 1248 / BS 1294**

Art. no. 282 906  
EAN 4 006 160 829 068

PU 1

**BS 1249**

Art. no. 282 907  
EAN 4 006 160 829 075

PU 1

**BS 1253**

Art. no. 282 914  
EAN 4 006 160 829 143

PU 1

**BS 1256**

Art. no. 271 596  
EAN 4 006 160 715 965

PU 1

**BS 1273 / BS 1281**

Art. no. 282 918  
EAN 4 006 160 829 181

PU 1

**BS 1276**

Art. no. 812 499  
EAN 4 006 160 124 996

PU 1

**BS 1280**

Art. no. 8 912 800  
EAN 4 600 160 128 000

PU 1

**BS 1286**

Art. no. 8 912 860  
EAN 4 600 160 128 604

PU 1

**BS 1293**

Art. no. 8 912 937  
EAN 4 600 160 129 373

PU 1

**Dust bags**

**SSB 101**

Suitable for:  
BS 1267 / BS 1268 / BS 1271 / BS 1274 /  
BS 1279 / BS 1288 / BS 1292 / BS 1296 /  
BS 1301

Art. no. 282 047  
EAN 4 006 160 820 478 PU 1

**SSB 98**

Suitable for:  
BS 1264 / BS 1272 / BS 1284 / BS 1287 /  
BS 1295 / BS 1300

Art. no. 282 193  
EAN 4 006 160 821 932 PU 1



**Replacement cartridges**

**Replacement cartridges for DBS 3461**  
Art. no. 8 934 610  
EAN 4 006 160 632 583 PU 3

**Replacement cartridges for DBS 3611**  
Art. no. 8 936 110  
EAN 4 006 160 632 606 PU 3

**Replacemant bottle / jars**

**Replacement bottle for Smoothie maker EF SM 3593**

Art. no. 264 559  
EAN 4006 160 645 590 PU 6

**Replacement jars for Yoghurt-Maker JM 3344**

Art. no. 251 125  
EAN 4006 160 511 253 PU 4



**Spare rolls for bag sealer**

**FS3261**  
Art. no.: 890 0216  
EAN 4 006 160 900 217 PU 10



**TECHNICAL DATA FOR VACUUM CLEANERS**  
Commission Delegated Regulation (EU) No. 665/2013

Clatronic										
Model	BS 1288	BS 1292	BS 1293	BS 1294	BS 1295	BS 1296	BS 1298	BS 1300	BS 1301	
Energy efficiency class <sup>1)</sup>	A	B	B	A	A	A	A	A	A	
<b>Energy consumption</b>										
Annual energy consumption <sup>2)</sup>	kWh	26.5	32.9	32.2	26.7	26.6	26.1	27.0	27.0	26.9
<b>Cleaning performance class</b>										
Carpet cleaning performance class	D	E	E	E	F	E	D	E	D	
Hard floor cleaning performance class	B	A	A	B	B	B	A	B	A	
<b>Dust re-emission class</b>										
Dust re-emission class	C	G	G	C	F	B	D	F	D	
Sound power level	dB(A) re 1pW	81	85	83	76	82	82	88	80	81
Rated input power	W	800	1.000	1.000	700	800	700	700	700	700

<sup>1)</sup> A (highest efficiency) to G (lowest efficiency).

<sup>2)</sup> Indicative annual energy consumption (kWh per year), based on 50 cleaning tasks. Actual annual energy consumption will depend on how the appliance is used.

**The device meets the European standards and directives in the current version at delivery:**

- Low Voltage Directive (LVD) 2006/95/EC
- Electromagnetic Compatibility (EMC) Legislation Directive 2004/108/EC
- Ecodesign requirements for vacuum cleaners COMMISSION REGULATION (EU) No 666/2013

**TECHNICAL DATA  
FOR AIR CONDITIONERS**

Commission Delegated Regulation (EU) No. Nr. 626/2011

Clatronic			
Model	CL 3542		
Energy efficiency class <sup>1)</sup>	A		
Description	<ul style="list-style-type: none"> <li>- portable-single ducted air conditioner</li> <li>- household use only</li> <li>- indoor use</li> <li>- single phase, cord connected</li> <li>- windows-type</li> </ul>		
	Symbol	Value	Unit
Rated capacity for cooling	P <sub>rated cooling</sub>	2.1	kW
Rated capacity for heating	P <sub>rated heating</sub>	-/-	kW
Rated power input for cooling	P <sub>EER</sub>	0.9	kW
Rated power input for heating	P <sub>COP</sub>	-/-	kW
Rated Energy efficiency ratio	EER <sub>d</sub>	2.6	-
Rated Coefficient of performance	COP <sub>d</sub>	-/-	-
Power consumption in thermostat-off mode	P <sub>TO</sub>	171.5	W
Power consumption in standby mode	P <sub>SB</sub>	1.0	W
Seasonal electricity consumption for single ducts (cooling)	Q	0.8	kWh / 60 min
Seasonal electricity consumption for single ducts (heating)	-	-/-	-
Sound power level	L <sub>WA</sub>	65	
Refrigerant	-	R410A	dB (A)
Global warming potential	GWP	1975	kgCO <sub>2</sub> eq.
<p>Refrigerant leakage contributes to climate change. Refrigerant with lower <b>global warming potential (GWP)</b> would contribute less to global warming than a refrigerant with higher GWP, if leaked to the atmosphere. This appliance contains a refrigerant fluid with a GWP equal to 1975. This means that if 1 kg of this refrigerant fluid would be leaked to the atmosphere, the impact on global warming would be 1975 times higher than 1 kg of CO<sub>2</sub>, over a period of 100 years. Never try to interfere with the refrigerant circuit yourself or disassemble the product yourself and always ask a professional.</p>			
Contact details for obtaining more information	Clatronic International GmbH Industriering Ost 40 - 47906 Kempen Germany		

<sup>1)</sup> A+++ (highest efficiency) to D (lowest efficiency).

Actual annual energy consumption will depend on how the appliance is used.

**The device meets the European standards and directives in the current version at delivery:**

- Low Voltage Directive (LVD) 2006/95/EC
- Electromagnetic Compatibility (EMC) Legislation Directive 2004/108/EC
- Ecodesign-directive (ErP) 2009/125/EC
- Ecodesign requirements for air conditioners and comfort fans COMMISSION REGULATION (EU) No 206/2012
- RoHS-directive 2011/65/EU

**TECHNICAL DATA  
FOR HOUSEHOLD REFRIGERATORS**

Commission Delegated Regulation (EU) No. 1060/2010

Clatronic			
Model	KB 3537	KB 3538	
Category <sup>1)</sup>	10	10	
Energy efficiency class <sup>2)</sup> A+++ (highest efficiency) to G (lowest efficiency)	A+	A++	
<b>Consumption data</b>			
Annual energy consumption <sup>3)</sup>	kWh	97	70
Net capacity cooling total	l	25	30
Net capacity freezing	l	0	0
Star rating <sup>4)</sup>	-	-	-
Frost-free	-	-	-
Temperature rise time	h	-	-
Freezing capacity	kg/ 24 h	-	-
<b>Climate class<sup>5)</sup></b>			
Noise level	dB(A) re 1pW	35	35
Design		mobil	mobil

<sup>1)</sup> Category: 1 = Refrigerator with one or more fresh-food storage compartments, 2 = Refrigerator-cellar, Cellar and Wine storage appliances, 3 = Refrigerator-chiller and Refrigerator with a 0-star compartment, 4 = Refrigerator with a one-star compartment, 5 = Refrigerator with a two-star compartment, 6 = Refrigerator with a three-star compartment, 7 = Refrigerator-freezer, 8 = Upright freezer, 9 = Chest freezer, 10 = Multi-use and other refrigerating appliances.

<sup>2)</sup> A+++ (highest efficiency) to G (lowest efficiency).

<sup>3)</sup> Annual energy consumption „XYZ“ kWh per year based on standard test results for 24 h.

Actual energy consumption will depend on how the appliance is used and where is located.

<sup>4)</sup> \* = compartment: a frozen-food storage compartment in which the temperature is not warmer than -6°C.

\*\*\* = compartment: a frozen-food storage compartment in which the temperature is not warmer than -18°C.

(\*)\*\*\*= food freezer compartment in which the temperature is not warmer than -18°C and a minimum freezing capacity in 24 h.

<sup>5)</sup> Climate class SN: ambient temperature of +10°C up to +32°C.

Climate class N: ambient temperature of +16°C up to +32°C.

Climate class ST: ambient temperature of +16°C up to +38°C.

Climate class T: ambient temperature of +16°C up to +43°C.



Headquarter



Logistic Center (approx. 60.000 m<sup>2</sup>)



Showroom



Quality assurance



CTC Clatronic Int. GmbH  
 Industriering Ost 40  
 D-47906 Kempen  
 Phone +49 (0) 21 52/20 06-0  
 Fax +49 (0) 21 52/20 06-19 99  
 info@clatronic.de  
 www.clatronic.com

CTC Clatronic Sp. z o. o.  
 Ul. Opolska 1a, Karczów  
 PL-49-120 Dąbrowa  
 Phone +48 (0) 77/44 77 900  
 Fax +48 (0) 77/44 77 943  
 clatronic@clatronic.pl  
 www.clatronic.pl

CLATRONIC Far East Ltd.  
 Unit 1045, 10/F, KITEC  
 1 Trademart Drive,  
 Kowloon Bay  
 Kowloon, Hong Kong  
 info@clatronic.com.hk  
 www.clatronic.com.hk